

# Mathematics Blackline Masters for Class VI

---

For use during teaching-learning process

Student Name: \_\_\_\_\_

School: \_\_\_\_\_



Department of School Education  
Ministry of Education and Skills Development  
Thimphu



# UNIT 1 FRACTIONS AND DECIMALS

## BLM 1 Fraction Match Game Cards

$\frac{1}{2}$	0.35	$1\frac{2}{3}$	$\frac{2}{5} + \frac{2}{5}$	$\frac{12}{3}$	0.23
4	$\frac{4}{5}$	$\frac{4}{6}$	$\frac{5}{3}$	$3\frac{3}{4}$	$\frac{4}{8}$
$\frac{5}{8}$	$4\frac{1}{2}$	0.5	$\frac{9}{2}$	$\frac{2}{8} + \frac{3}{8}$	0.6
$\frac{15}{4}$	$\frac{7}{8} - \frac{3}{8}$	$\frac{6}{10}$	$\frac{23}{100}$	$\frac{3}{10} + \frac{5}{100}$	$\frac{5}{6} - \frac{1}{6}$

THIS PAGE IS LEFT BLANK

# BLM 2 Fraction Strips

1											
$\frac{1}{2}$						$\frac{1}{2}$					
$\frac{1}{3}$				$\frac{1}{3}$				$\frac{1}{3}$			
$\frac{1}{4}$			$\frac{1}{4}$			$\frac{1}{4}$			$\frac{1}{4}$		
$\frac{1}{5}$		$\frac{1}{5}$		$\frac{1}{5}$		$\frac{1}{5}$		$\frac{1}{5}$		$\frac{1}{5}$	
$\frac{1}{6}$		$\frac{1}{6}$		$\frac{1}{6}$		$\frac{1}{6}$		$\frac{1}{6}$		$\frac{1}{6}$	
$\frac{1}{8}$	$\frac{1}{8}$	$\frac{1}{8}$	$\frac{1}{8}$	$\frac{1}{8}$	$\frac{1}{8}$	$\frac{1}{8}$	$\frac{1}{8}$	$\frac{1}{8}$	$\frac{1}{8}$	$\frac{1}{8}$	$\frac{1}{8}$
$\frac{1}{9}$	$\frac{1}{9}$	$\frac{1}{9}$	$\frac{1}{9}$	$\frac{1}{9}$	$\frac{1}{9}$	$\frac{1}{9}$	$\frac{1}{9}$	$\frac{1}{9}$	$\frac{1}{9}$	$\frac{1}{9}$	$\frac{1}{9}$
$\frac{1}{10}$	$\frac{1}{10}$	$\frac{1}{10}$	$\frac{1}{10}$	$\frac{1}{10}$	$\frac{1}{10}$	$\frac{1}{10}$	$\frac{1}{10}$	$\frac{1}{10}$	$\frac{1}{10}$	$\frac{1}{10}$	$\frac{1}{10}$
$\frac{1}{12}$	$\frac{1}{12}$	$\frac{1}{12}$	$\frac{1}{12}$	$\frac{1}{12}$	$\frac{1}{12}$	$\frac{1}{12}$	$\frac{1}{12}$	$\frac{1}{12}$	$\frac{1}{12}$	$\frac{1}{12}$	$\frac{1}{12}$

THIS PAGE IS LEFT BLANK

**BLM 3 Pattern Block Fraction Pieces**

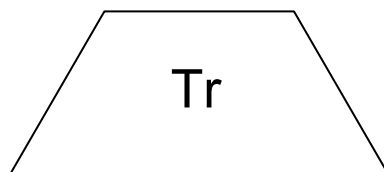
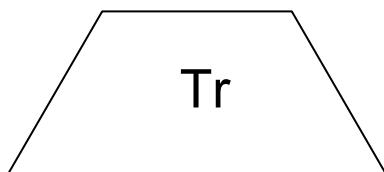
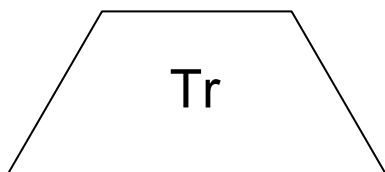
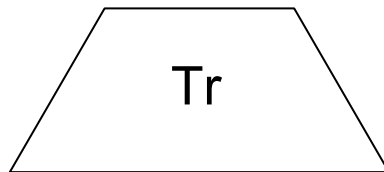
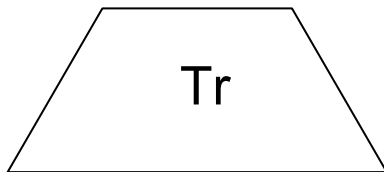
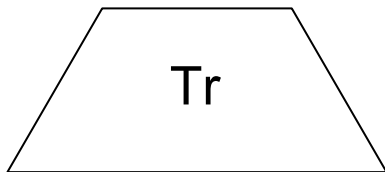
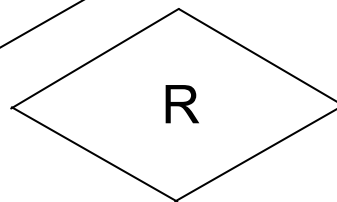
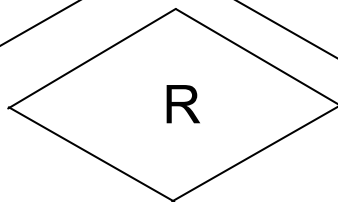
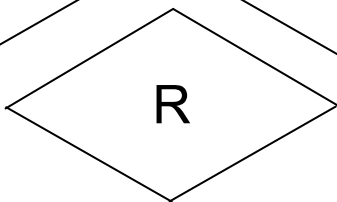
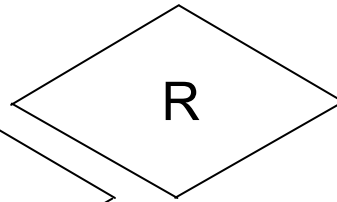
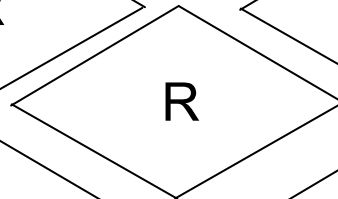
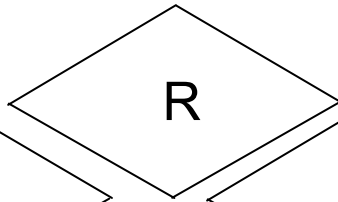
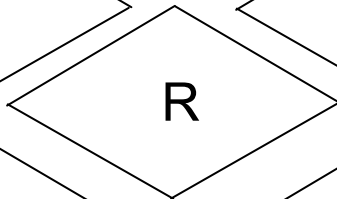
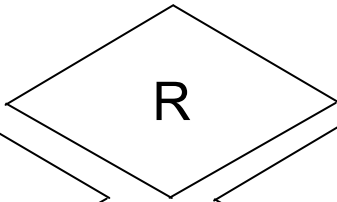
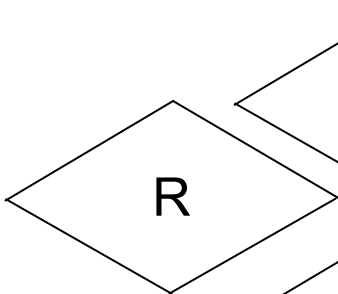
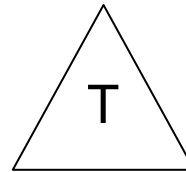
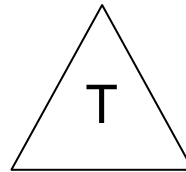
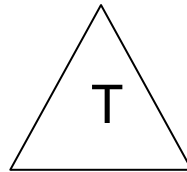
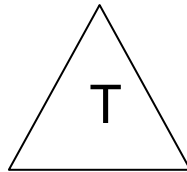
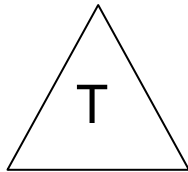
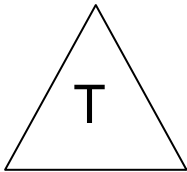
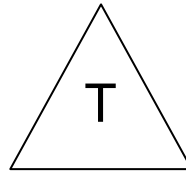
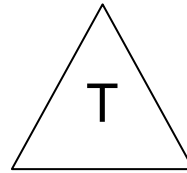
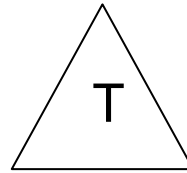
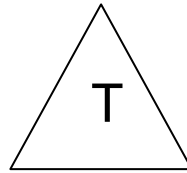
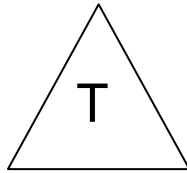
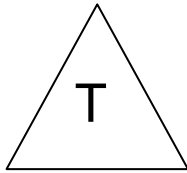
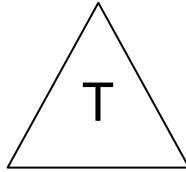
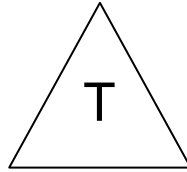
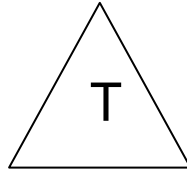
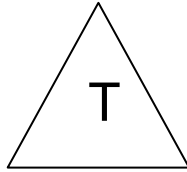
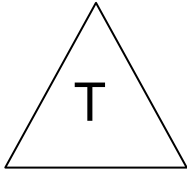
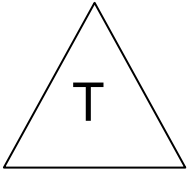
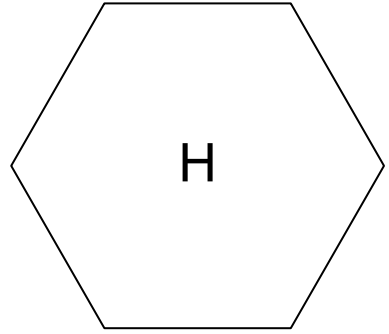
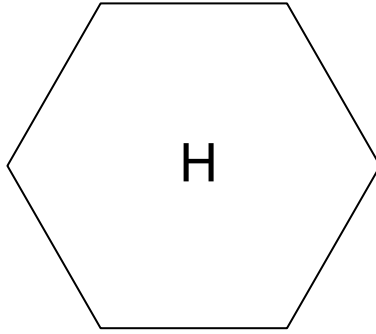
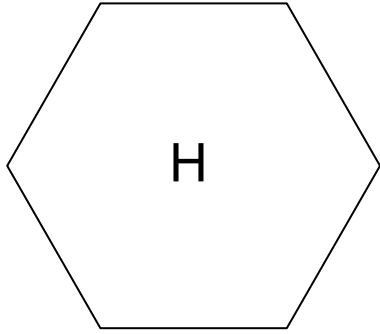

THIS PAGE IS LEFT BLANK



# BLM 4 Hundredths Grids

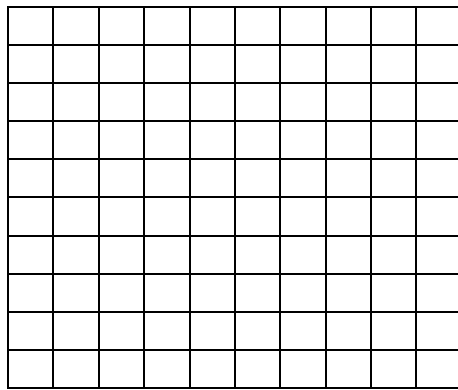
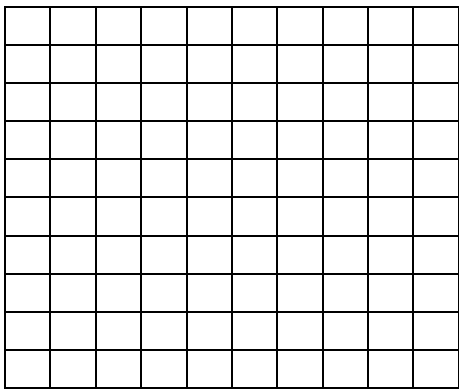
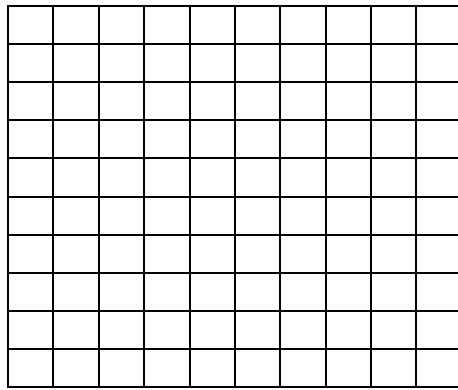
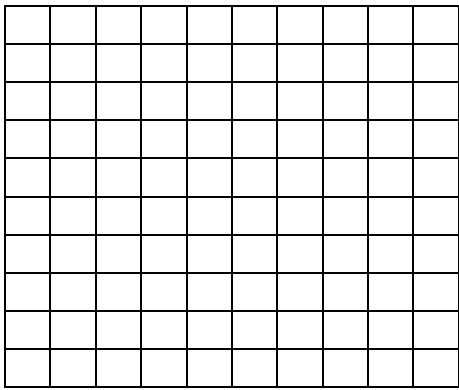
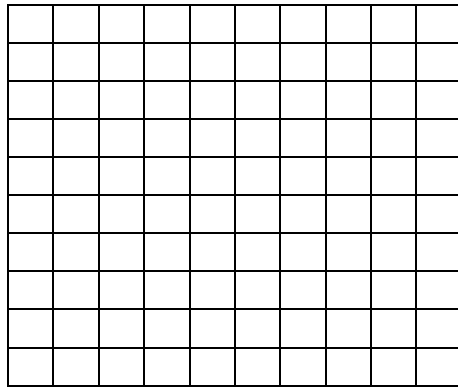
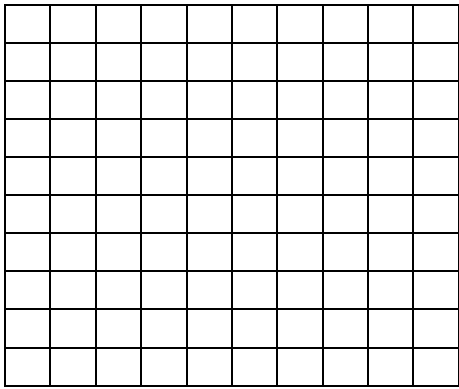
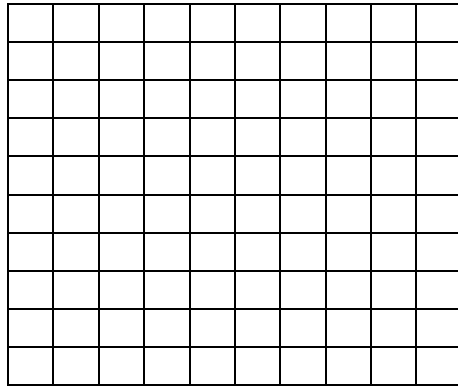
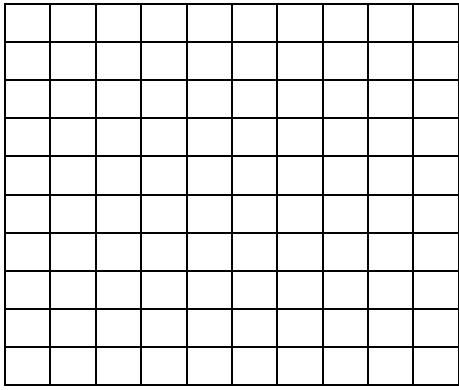

THIS PAGE IS LEFT BLANK

**BLM 5 Small Grid Paper**

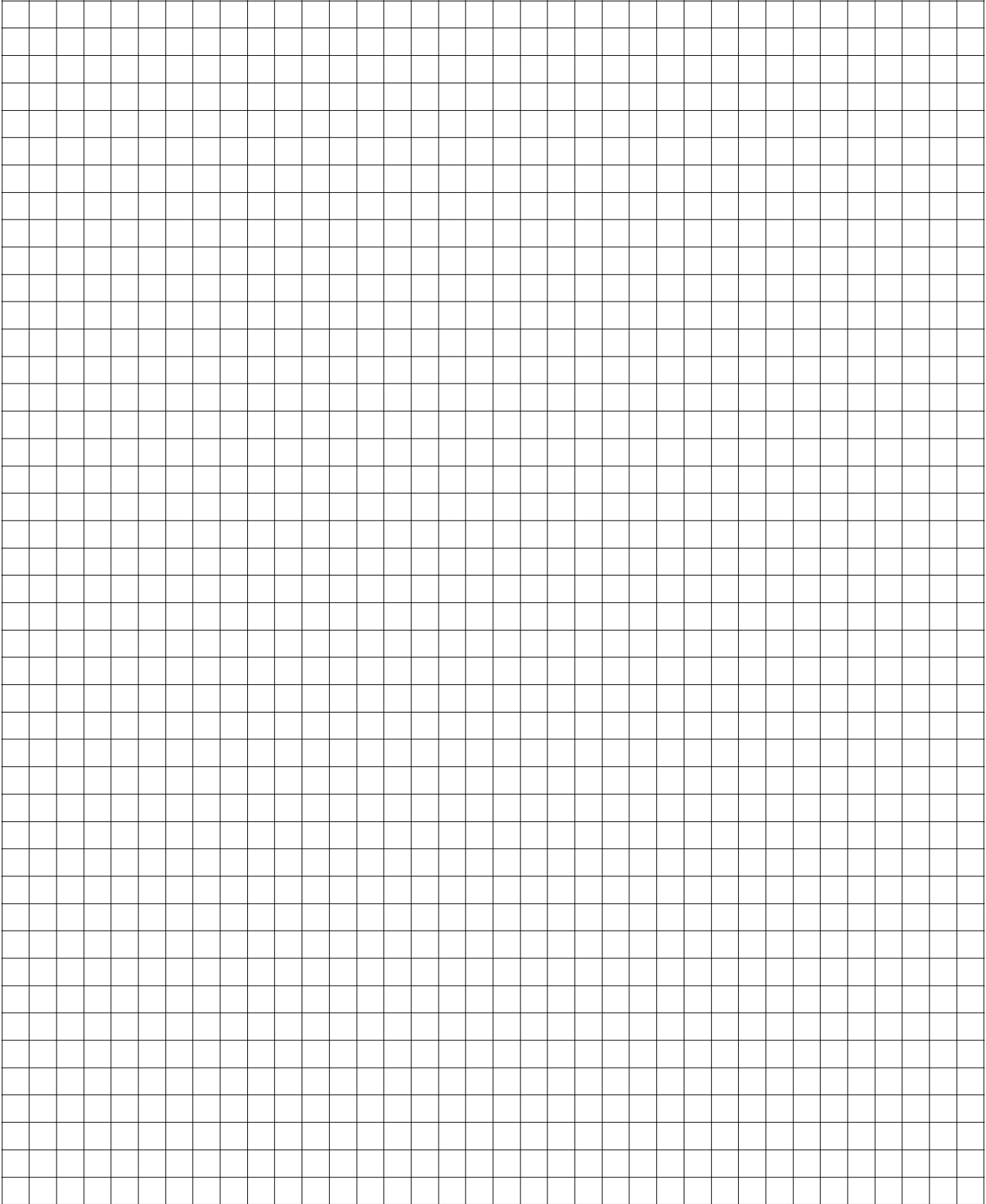

THIS PAGE IS LEFT BLANK

# UNIT 2 GEOMETRY

## BLM 1 Tessellating Shapes

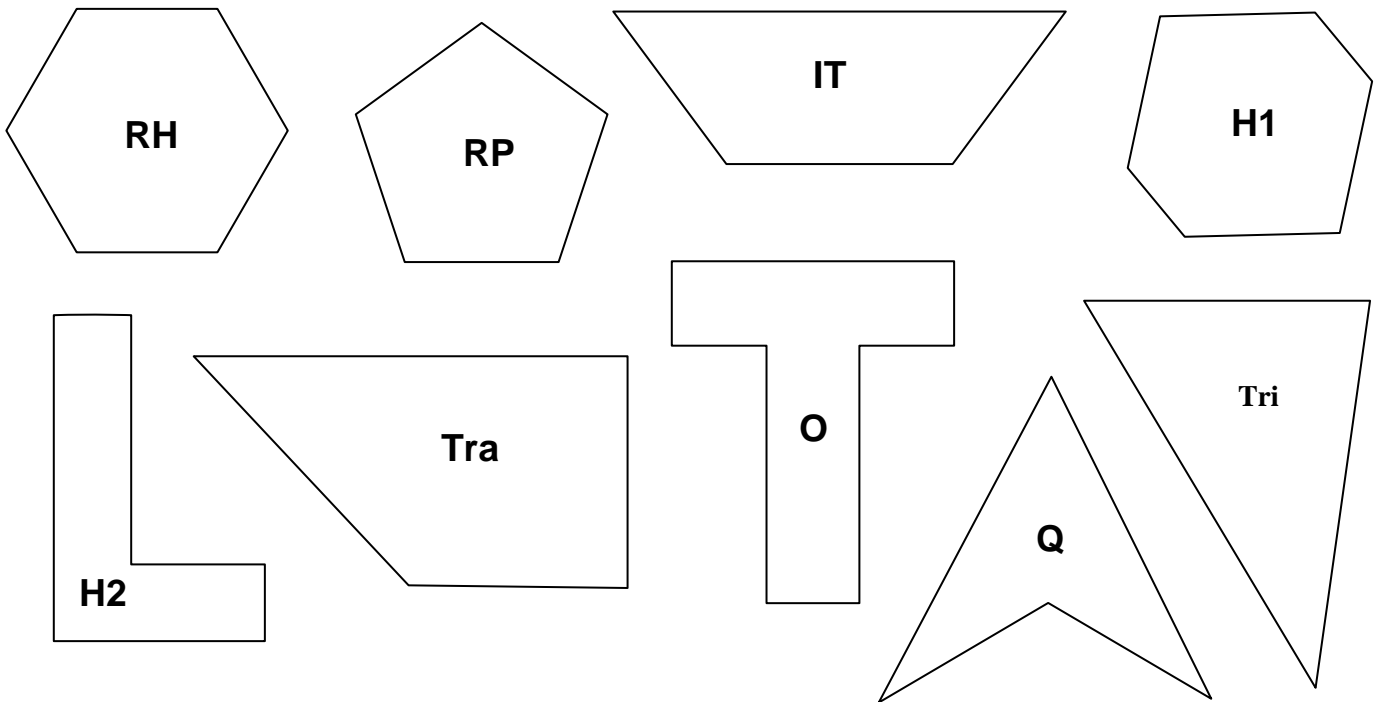
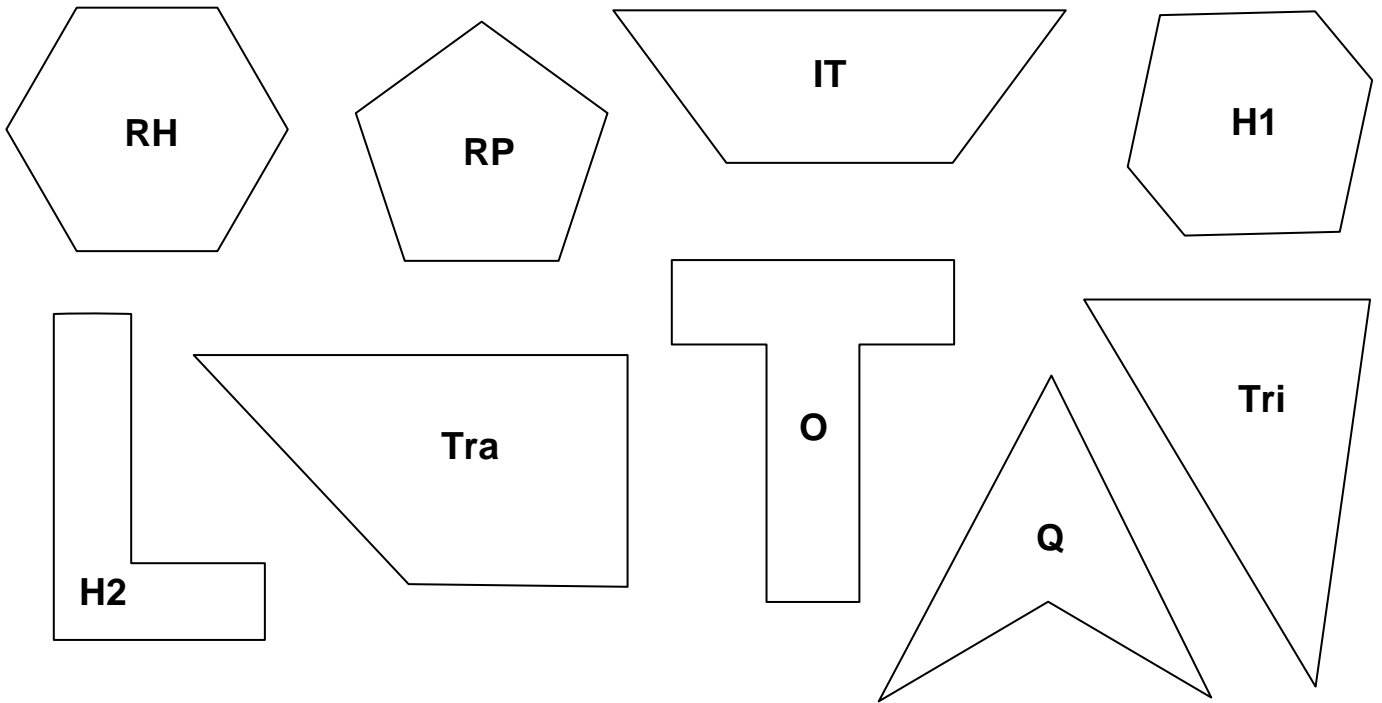

THIS PAGE IS LEFT BLANK

## BLM 2 Paper Protractors

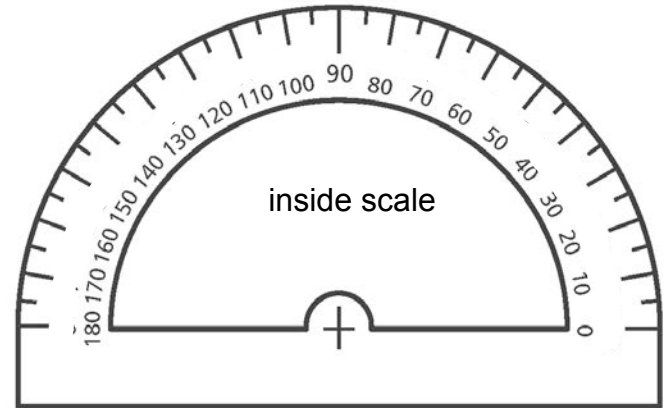
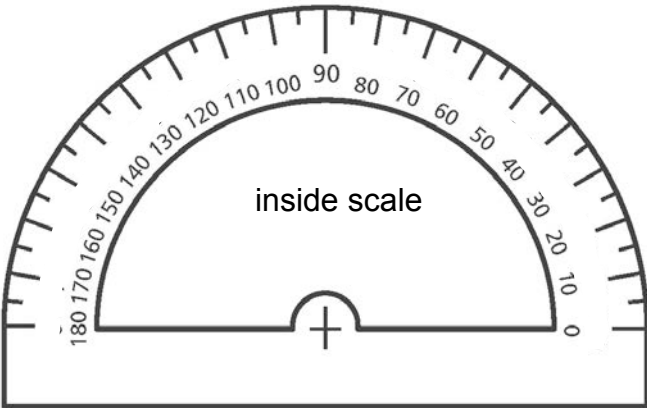
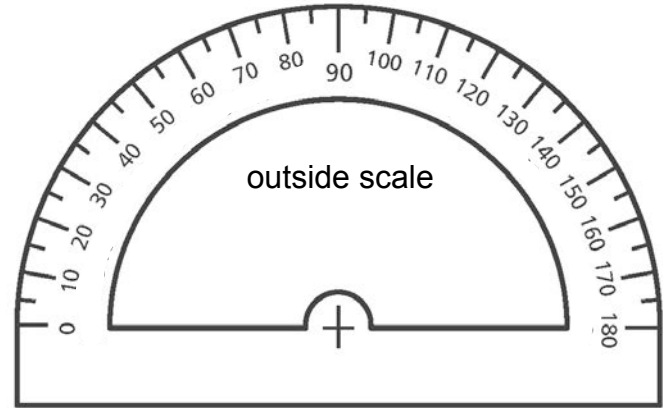
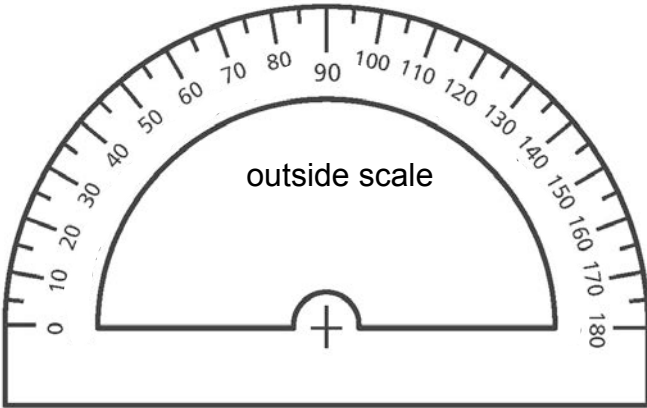
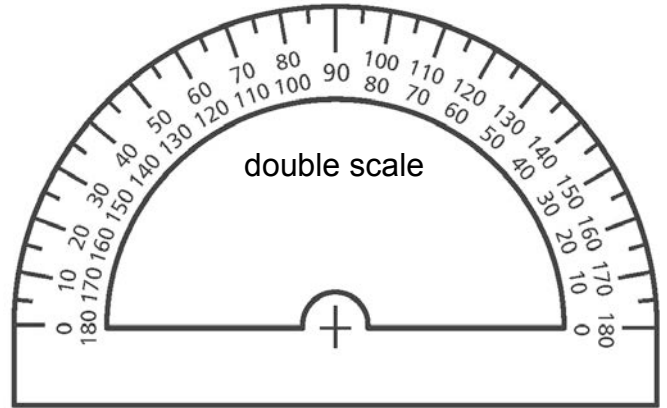
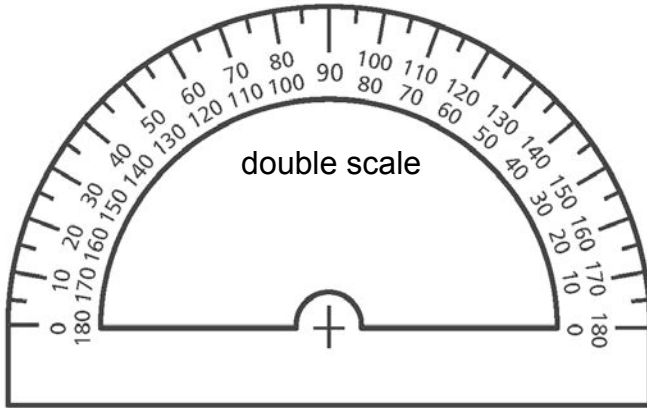
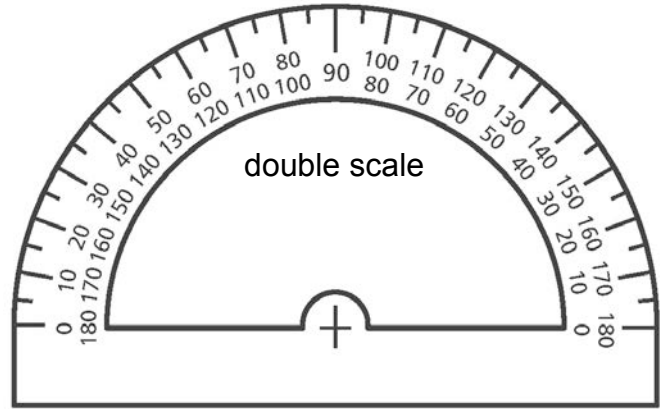
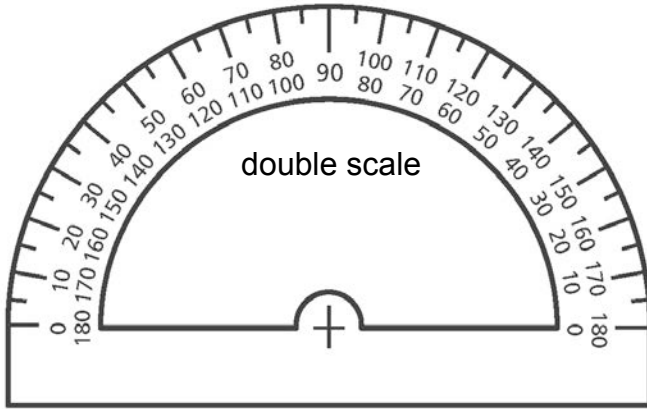

THIS PAGE IS LEFT BLANK



# BLM 3 Field Angles



THIS PAGE IS LEFT BLANK

BLM 4 Angle Bisectors

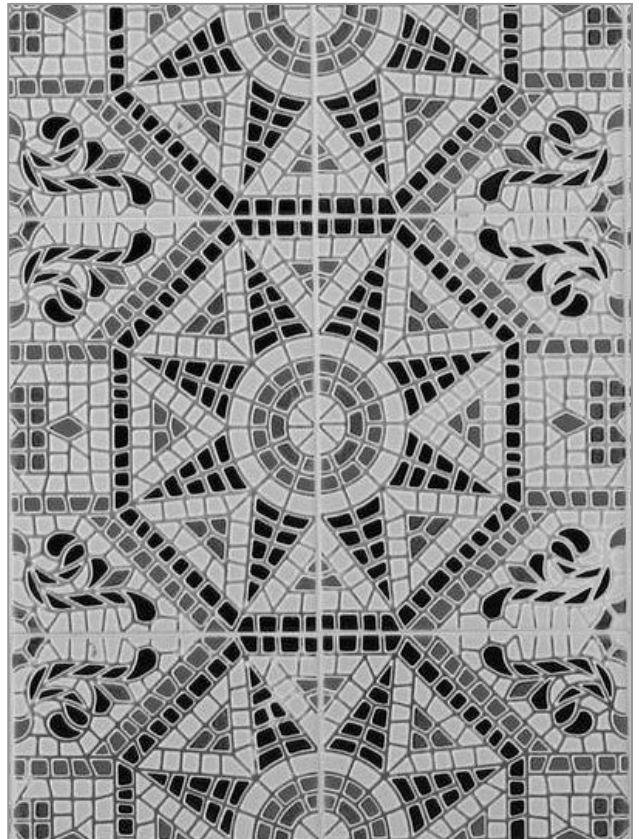
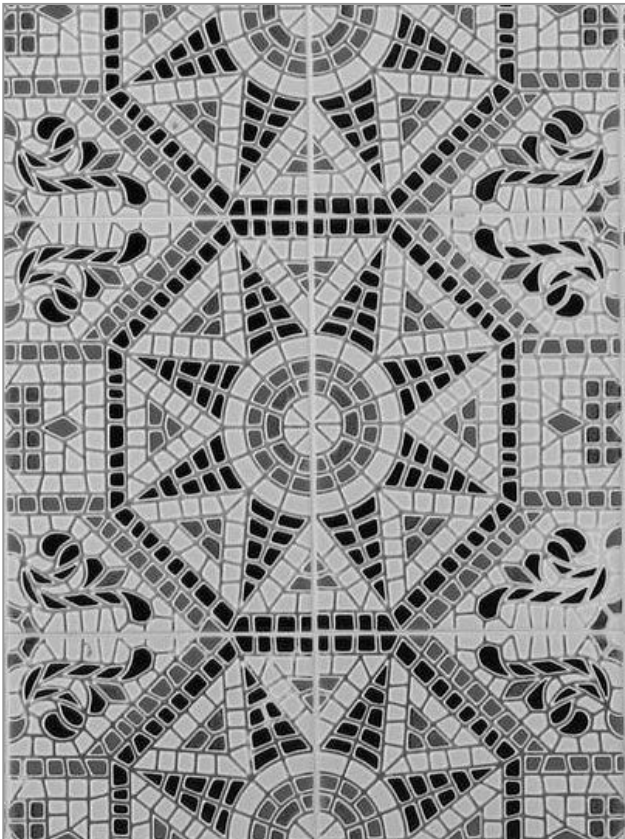
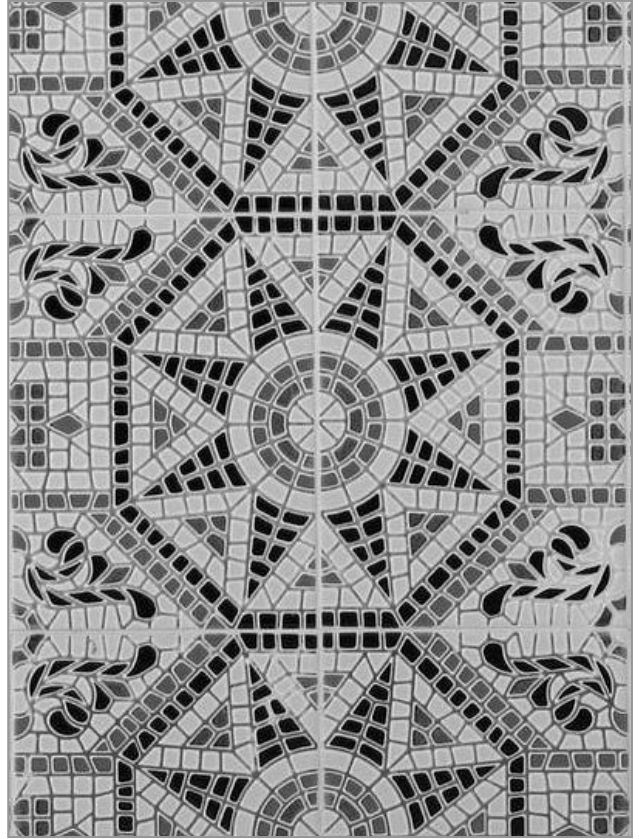
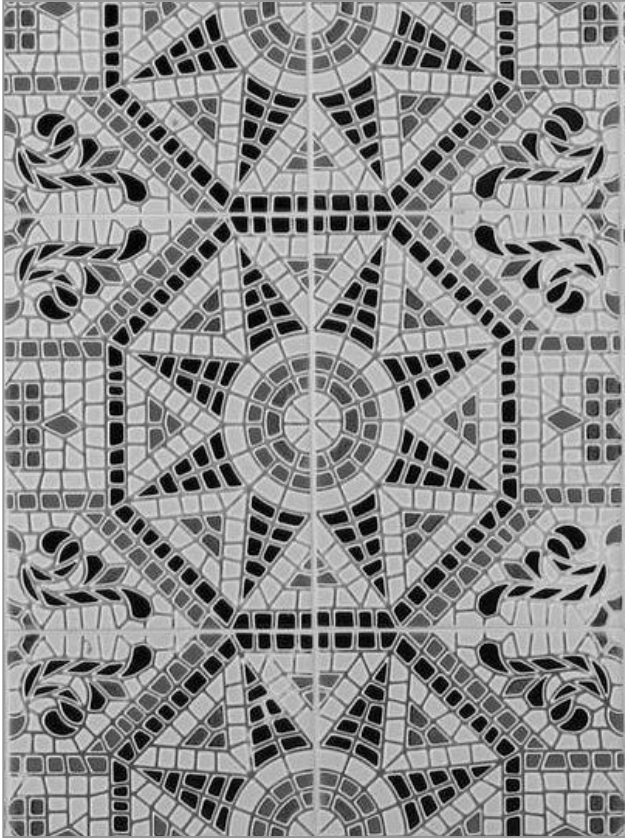

THIS PAGE IS LEFT BLANK

# BLM 5 Sorting Quadrilaterals

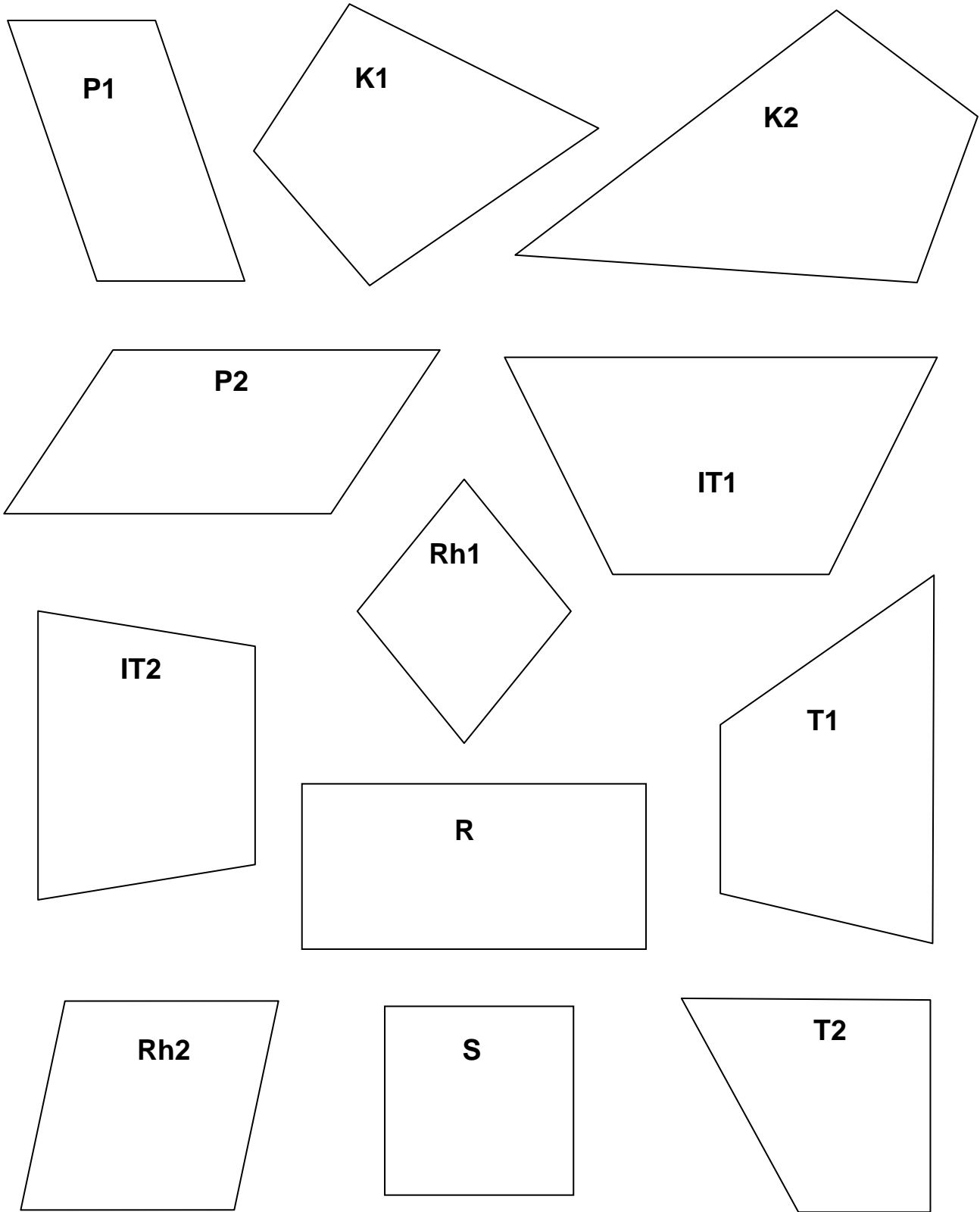

THIS PAGE IS LEFT BLANK

# BLM 6 Go Fish Game Cards

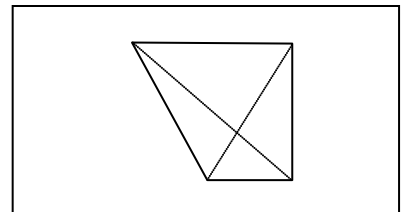
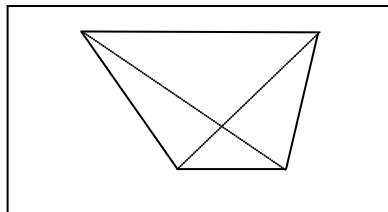
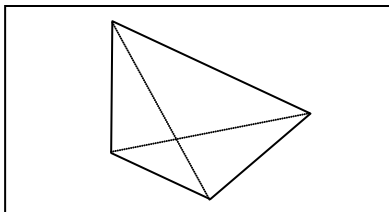
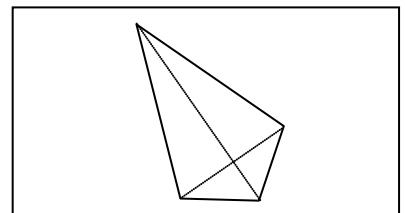
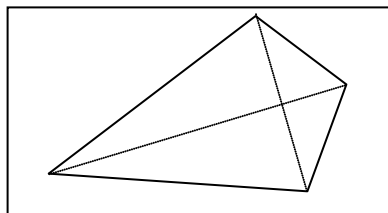
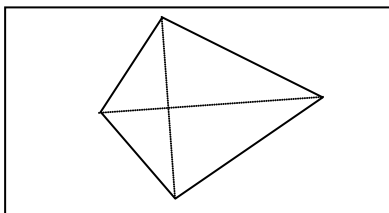
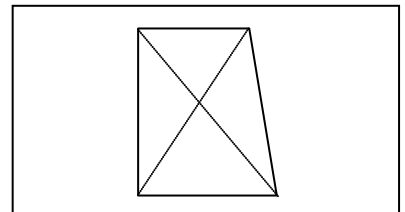
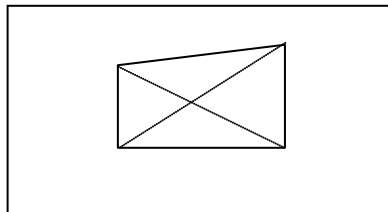
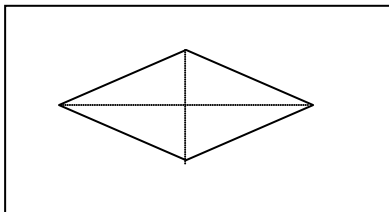
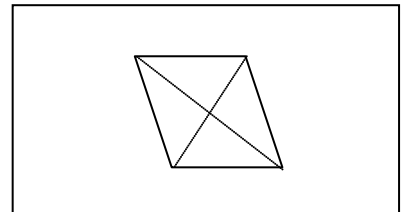
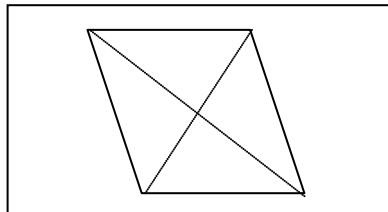
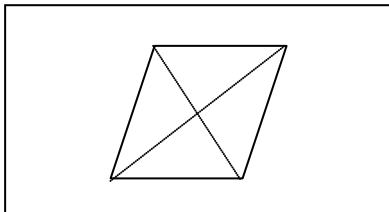
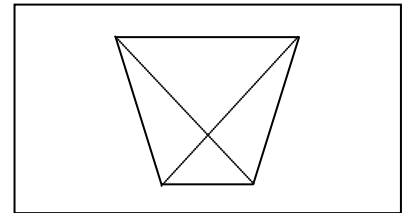
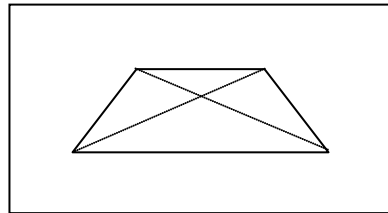
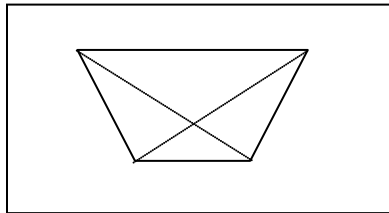
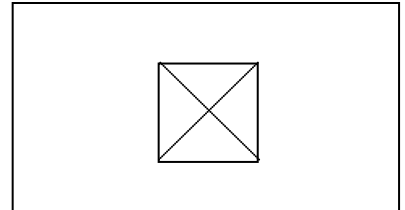
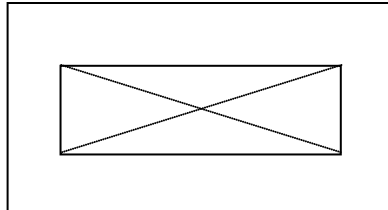
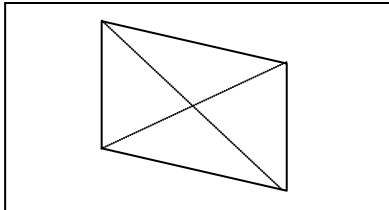
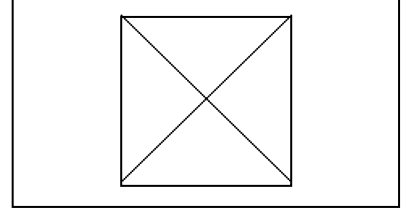
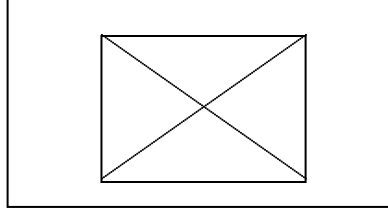
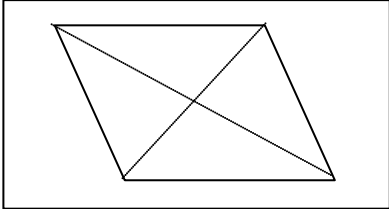
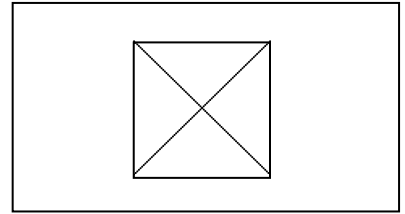
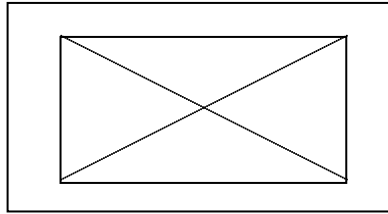
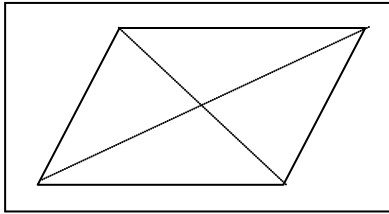

THIS PAGE IS LEFT BLANK



**BLM 7 Sample Net of Cube**

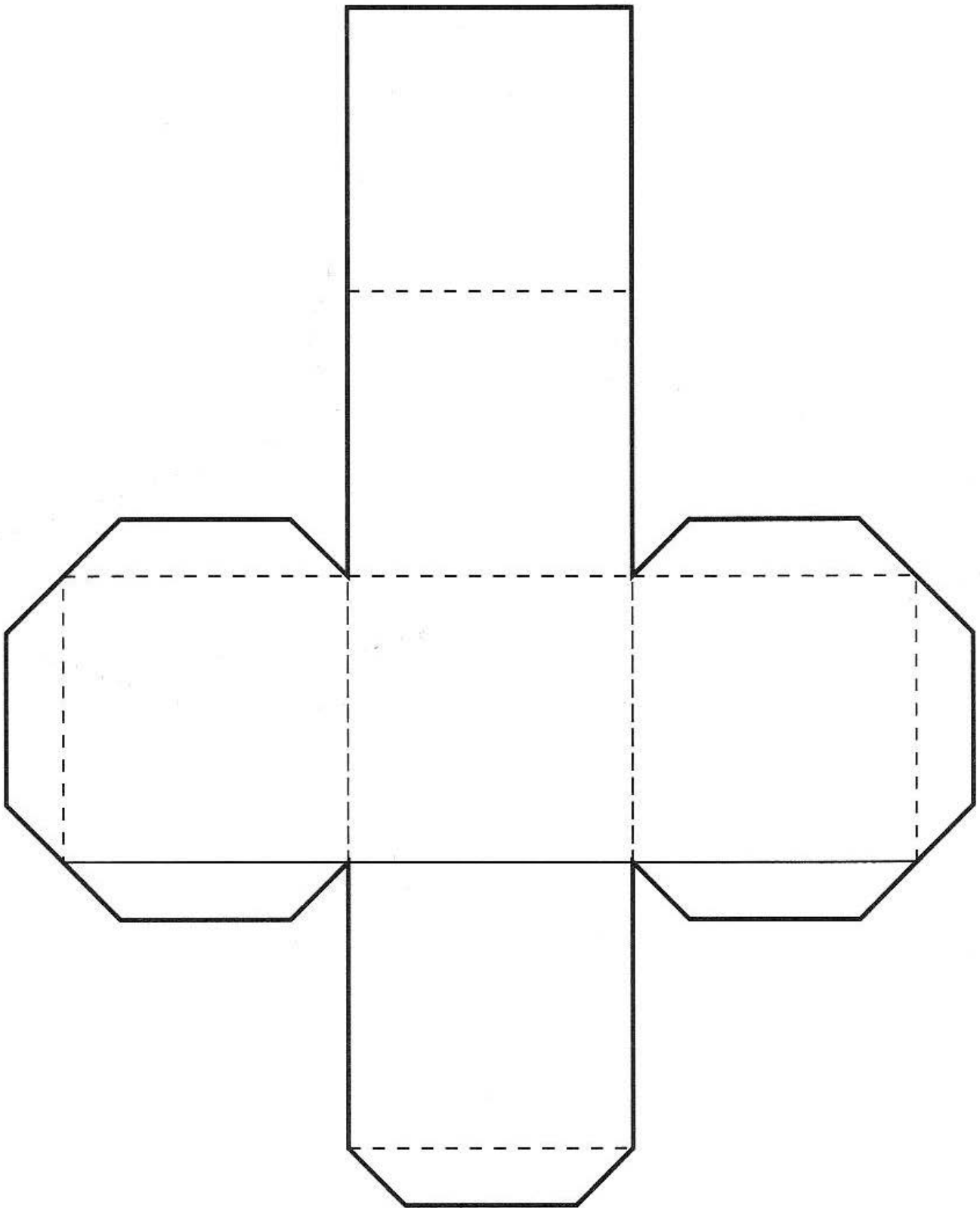

THIS PAGE IS LEFT BLANK

**BLM 8 Sample Net of Right Triangle-based Prism**

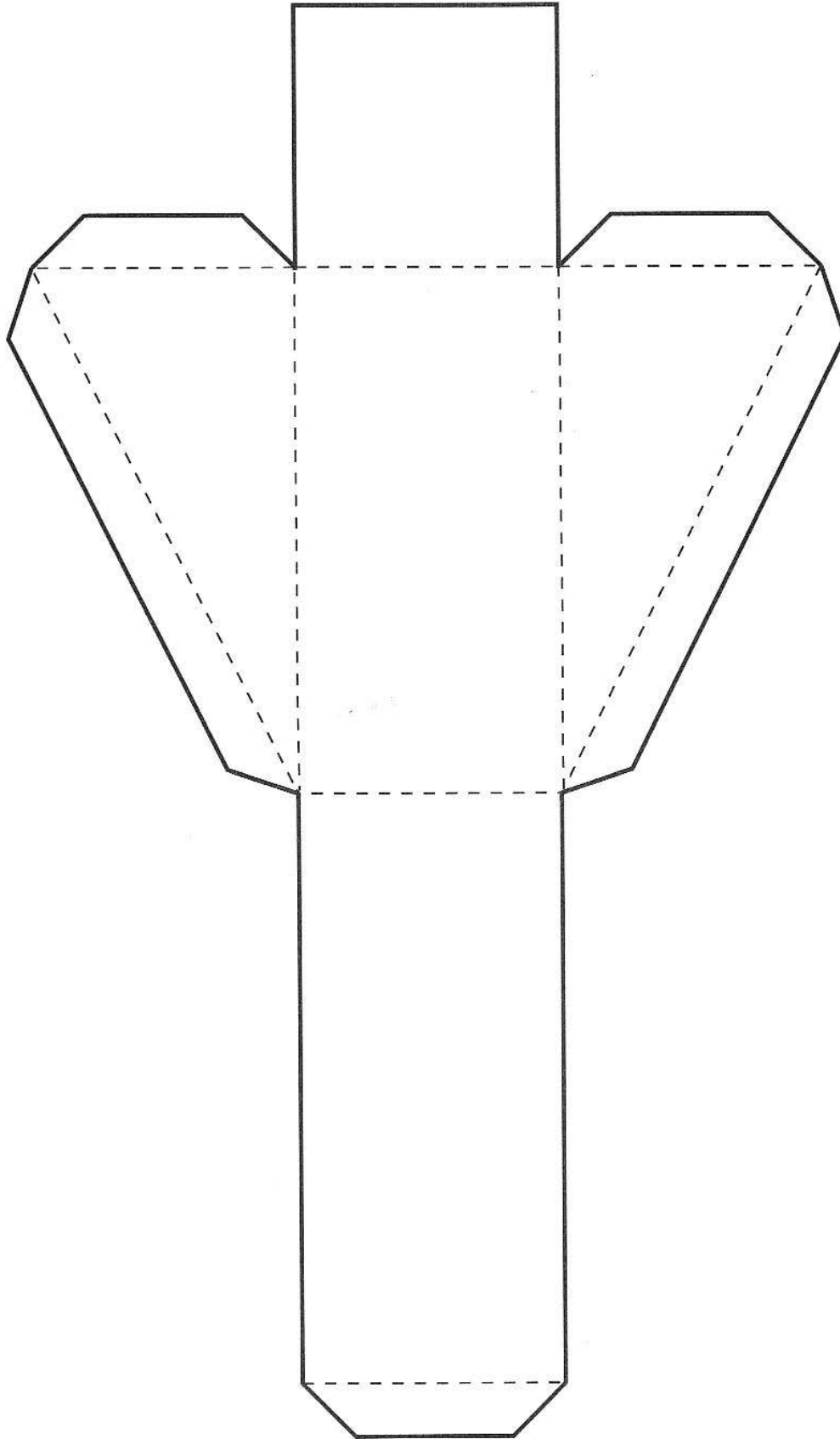

THIS PAGE IS LEFT BLANK

**BLM 9 Sample Net of Rectangle-based Prism**

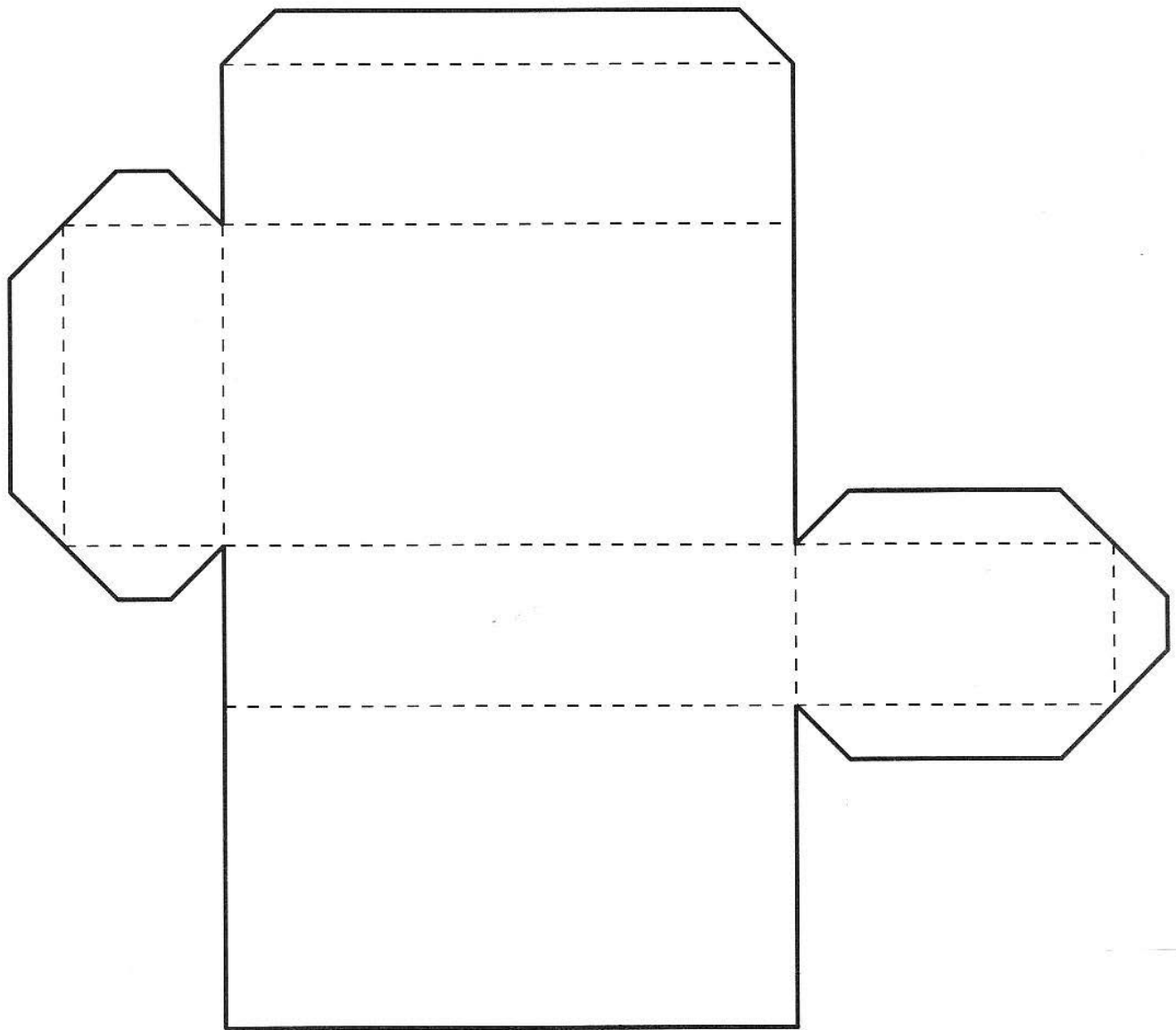

THIS PAGE IS LEFT BLANK

**BLM 10 Sample Net of Square-based Pyramid**

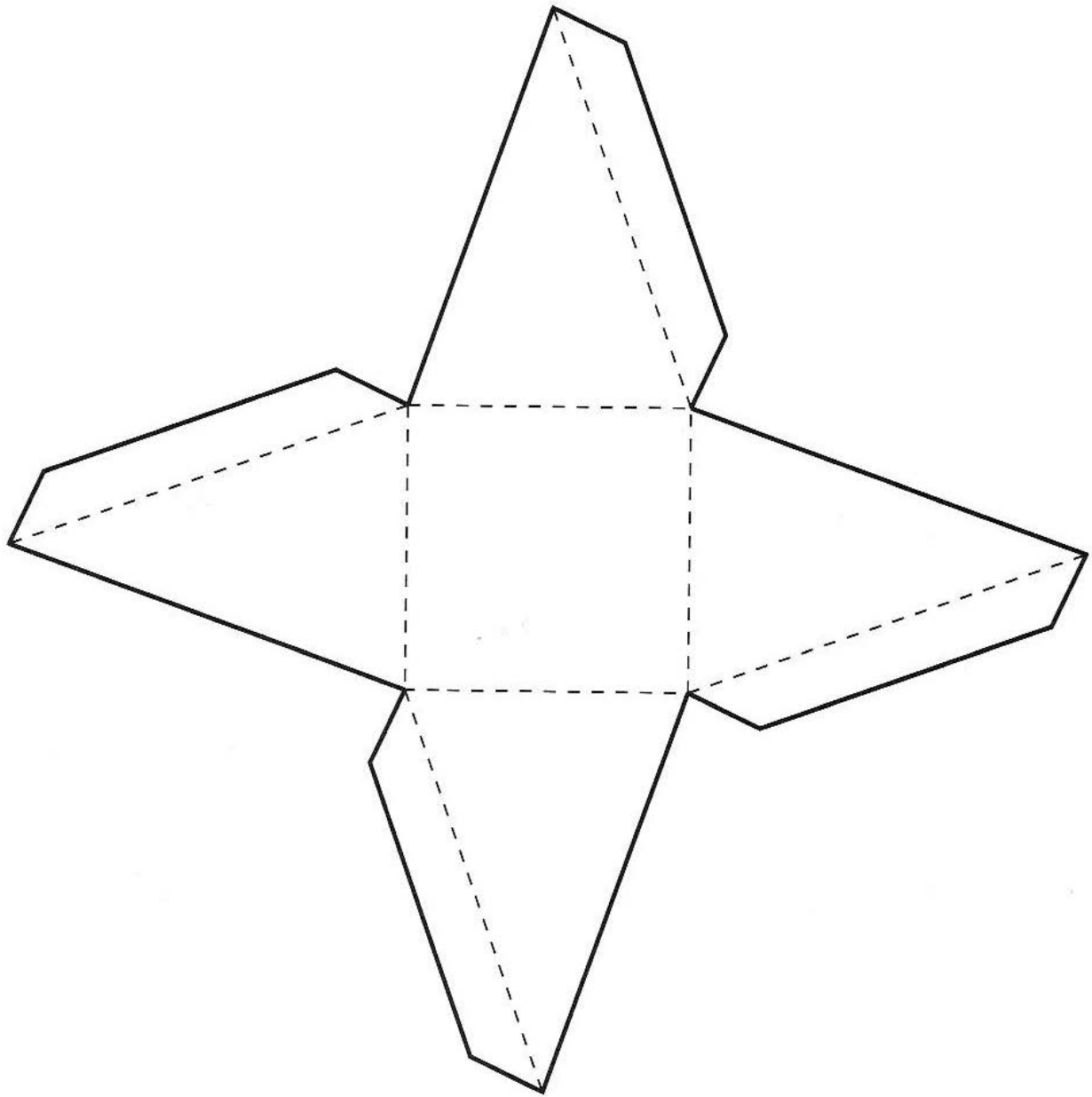

THIS PAGE IS LEFT BLANK



**BLM 11 Sample Net of Regular Hexagon-based Prism**

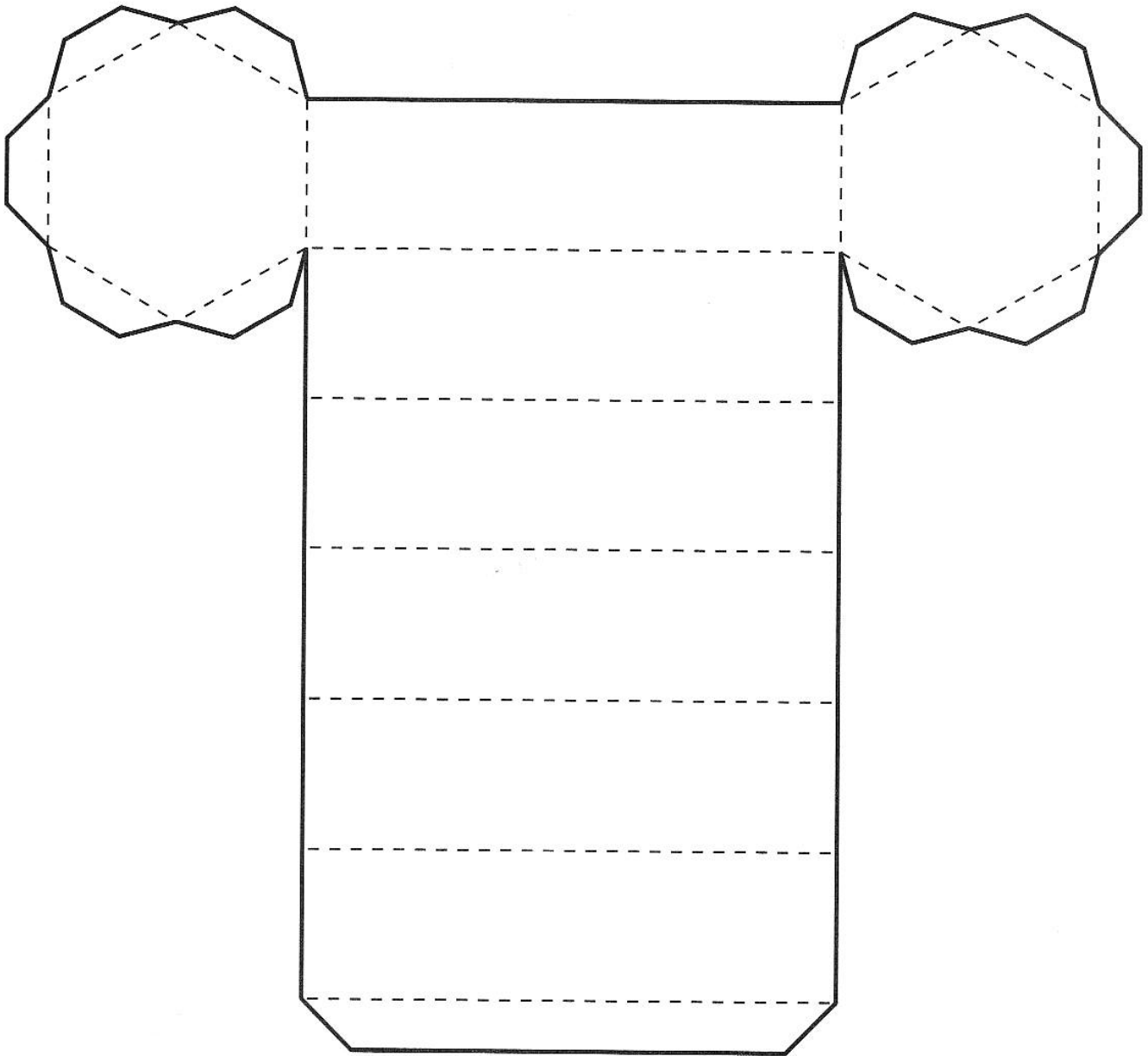

THIS PAGE IS LEFT BLANK

**BLM 12 Grid Paper (1 cm by 1 cm)**

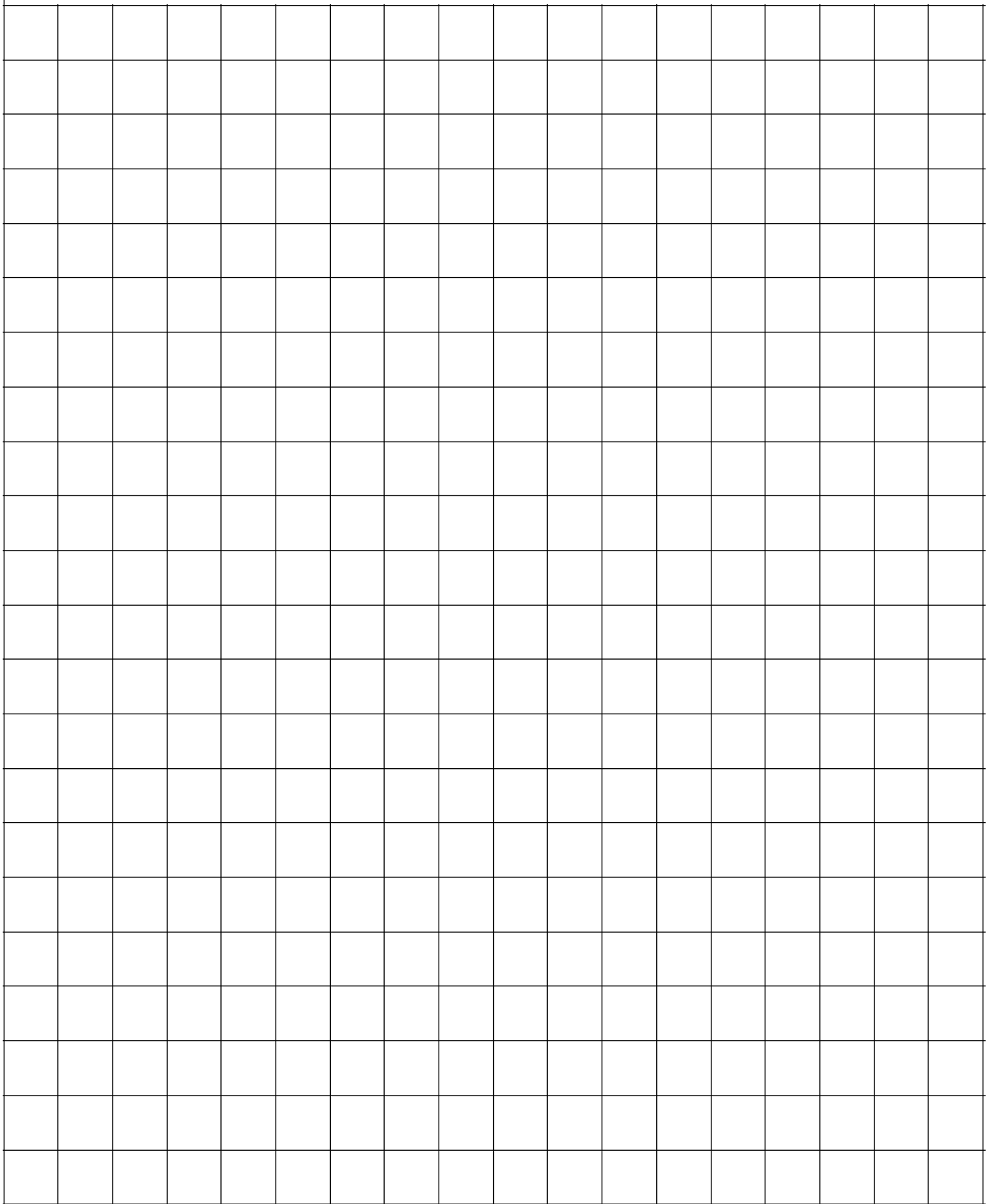

THIS PAGE IS LEFT BLANK

# UNIT 3 DECIMAL COMPUTATION

## BLM 1 Place Value Charts I

Tens	Ones	Tenths	Hundredths	Thousandths

Tens	Ones	Tenths	Hundredths	Thousandths

Tens	Ones	Tenths	Hundredths	Thousandths

Tens	Ones	Tenths	Hundredths	Thousandths

Tens	Ones	Tenths	Hundredths	Thousandths

Tens	Ones	Tenths	Hundredths	Thousandths

Tens	Ones	Tenths	Hundredths	Thousandths

Tens	Ones	Tenths	Hundredths	Thousandths

THIS PAGE IS LEFT BLANK

**BLM 2A Base Ten Models (Hundreds, Tens, and Ones)**

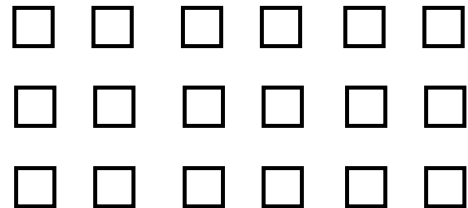
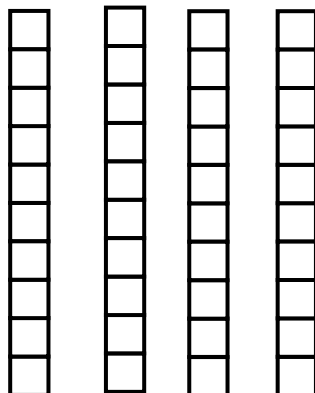
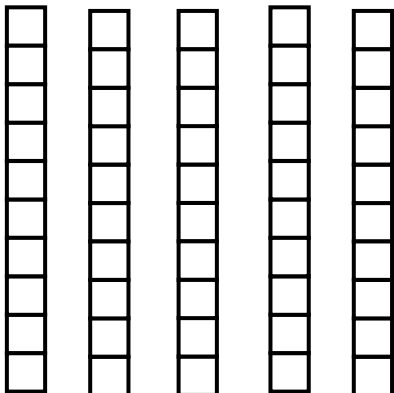
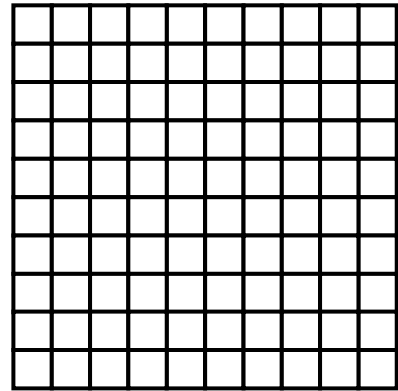
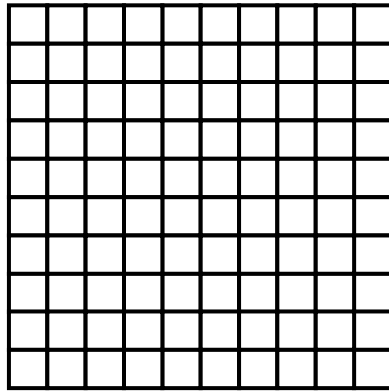
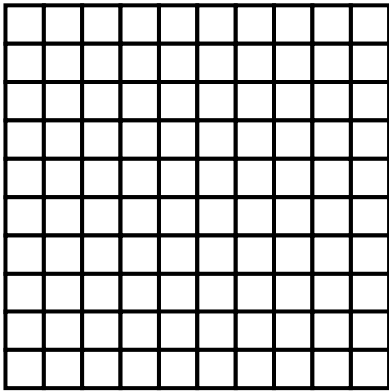
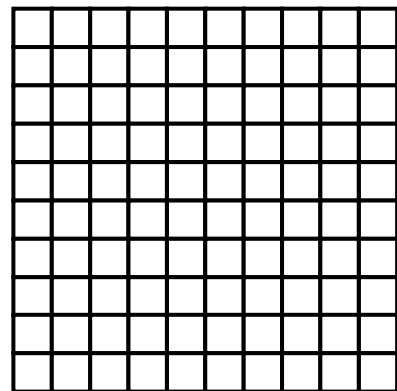
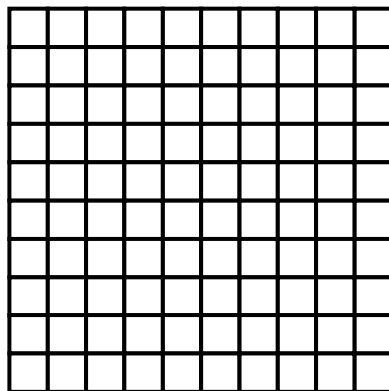
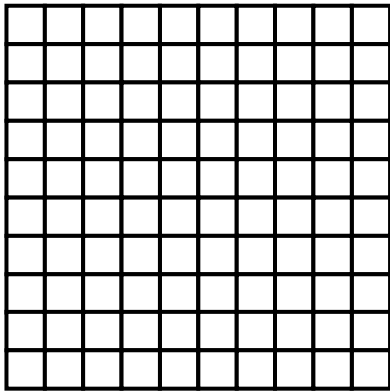
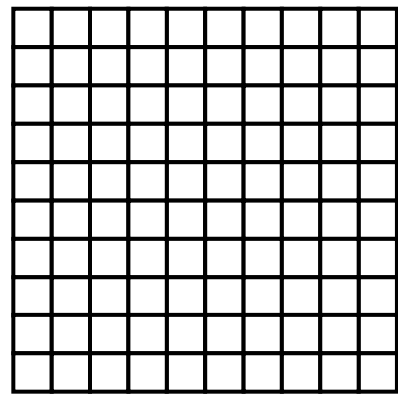
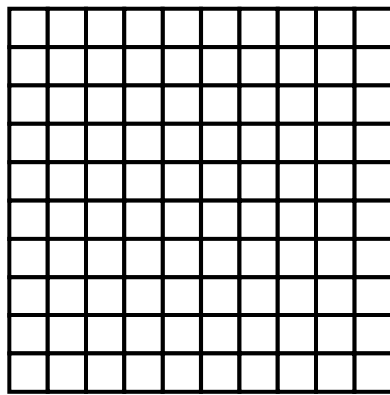
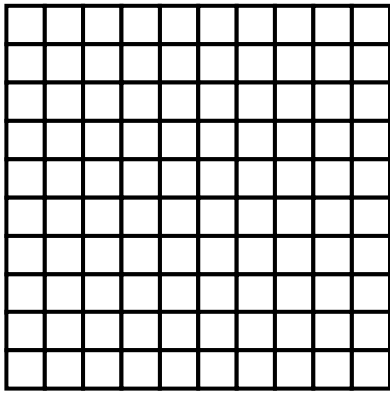

THIS PAGE IS LEFT BLANK



BLM 2B Base Ten Models (Thousands)

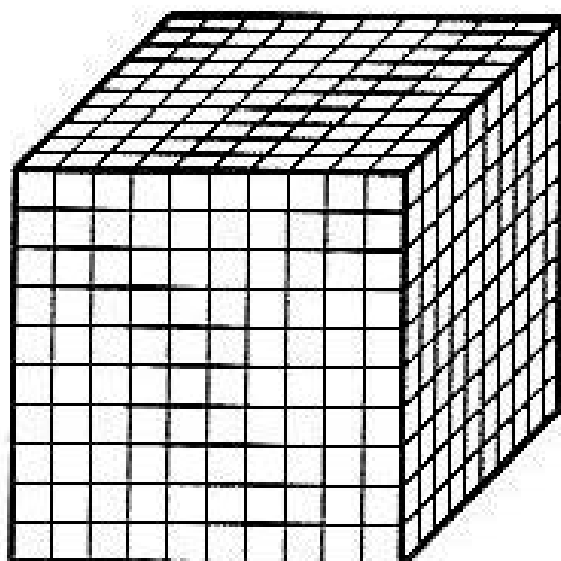
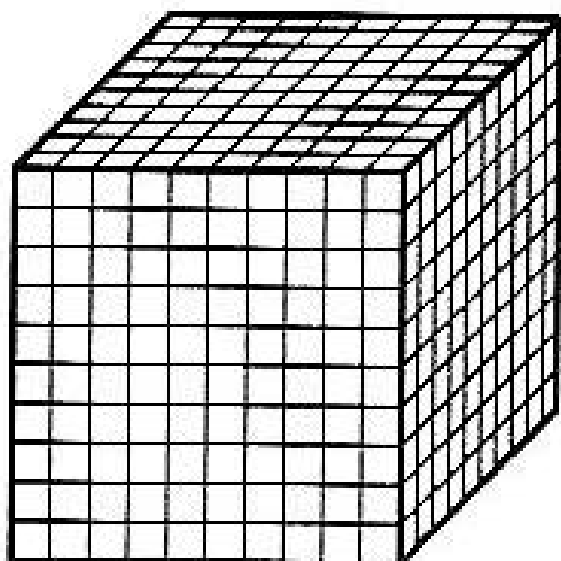
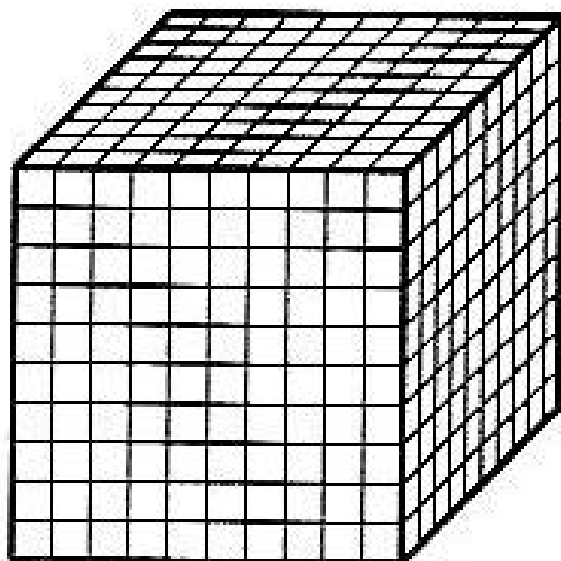
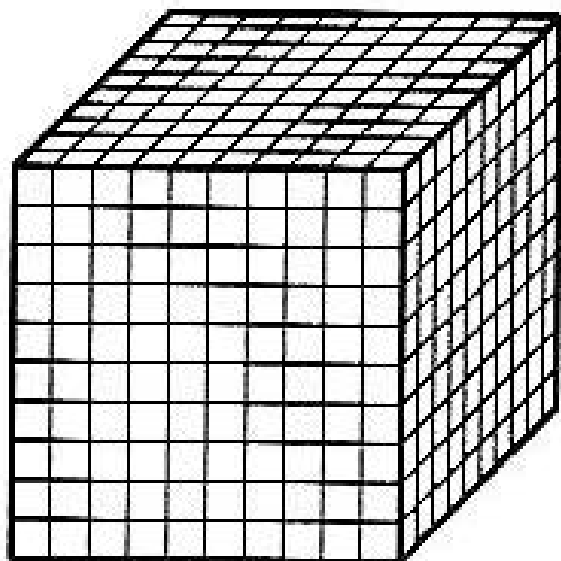
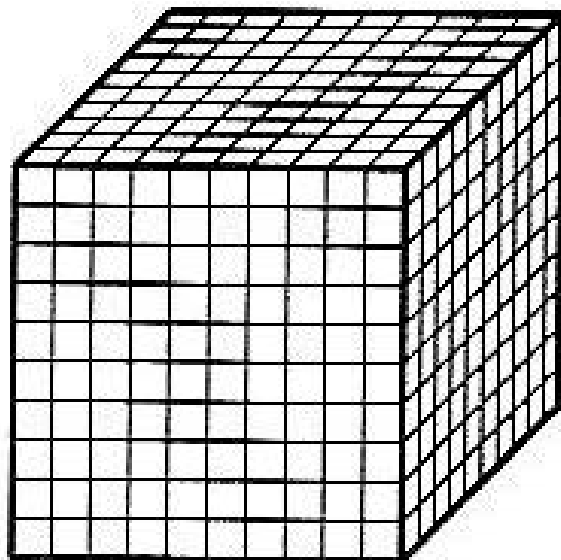
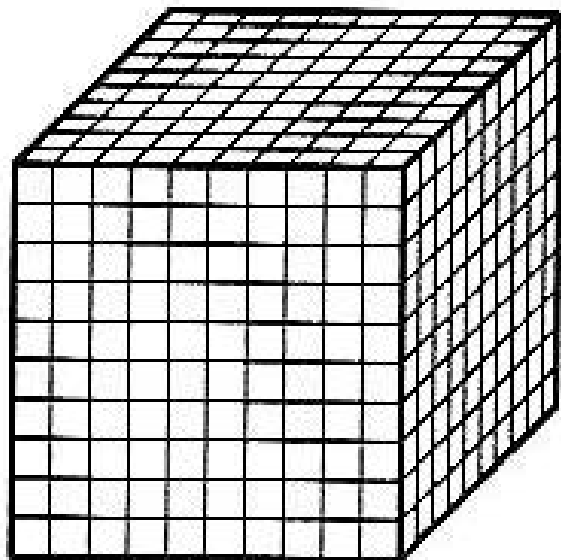

THIS PAGE IS LEFT BLANK

# UNIT 4 MEASUREMENT

## BLM 1 Square Dot Grid Paper

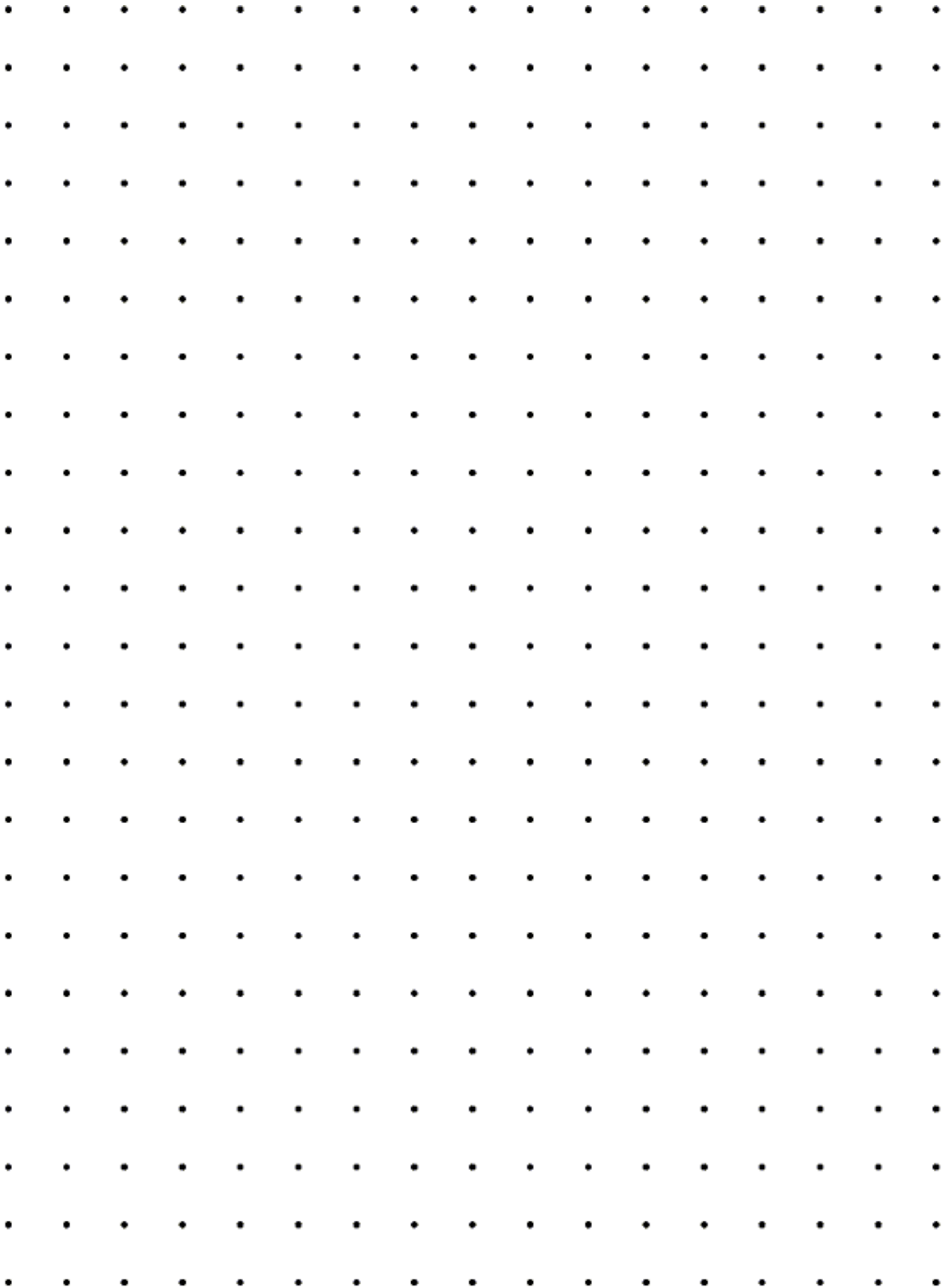

THIS PAGE IS LEFT BLANK

# UNIT 5 RATIO, RATE, AND PERCENT

## BLM 1 Getting Started Squares

THIS PAGE IS LEFT BLANK

**BLM 2 Ratio Match Game Cards**

2 : 4	0.75	16%	0.33	0.40	10%
1 : 10	0.23	80%	$\frac{2}{5}$	2 : 3	75%
$\frac{4}{6}$	$\frac{8}{10}$	50%	4 : 6	40%	54%
75 : 100	0.54	23%	$\frac{4}{5}$	0.16	$\frac{2}{3}$
0.1	33%	2 : 5	$\frac{1}{10}$	$\frac{3}{4}$	0.80

THIS PAGE IS LEFT BLANK



# UNIT 6 NUMBER RELATIONSHIPS

## BLM 1 Place Value Charts II

Billions	Millions			Thousands			Ones		
One	Hundred	Ten	One	Hundred	Ten	One	Hundred	Ten	One

Billions	Millions			Thousands			Ones		
One	Hundred	Ten	One	Hundred	Ten	One	Hundred	Ten	One

Billions	Millions			Thousands			Ones		
One	Hundred	Ten	One	Hundred	Ten	One	Hundred	Ten	One

Billions	Millions			Thousands			Ones		
One	Hundred	Ten	One	Hundred	Ten	One	Hundred	Ten	One

Billions	Millions			Thousands			Ones		
One	Hundred	Ten	One	Hundred	Ten	One	Hundred	Ten	One

THIS PAGE IS LEFT BLANK

**BLM 2 Place Value Charts III**

Tens	Ones	Tenths	Hundredths	Thousandths	Ten thousandths

Tens	Ones	Tenths	Hundredths	Thousandths	Ten thousandths

Tens	Ones	Tenths	Hundredths	Thousandths	Ten thousandths

Tens	Ones	Tenths	Hundredths	Thousandths	Ten thousandths

Tens	Ones	Tenths	Hundredths	Thousandths	Ten thousandths

Tens	Ones	Tenths	Hundredths	Thousandths	Ten thousandths

THIS PAGE IS LEFT BLANK

### BLM 3 100 Charts

1	2	3	4	5	6	7	8	9	10
11	12	13	14	15	16	17	18	19	20
21	22	23	24	25	26	27	28	29	30
31	32	33	34	35	36	37	38	39	40
41	42	43	44	45	46	47	48	49	50
51	52	53	54	55	56	57	58	59	60
61	62	63	64	65	66	67	68	69	70
71	72	73	74	75	76	77	78	79	80
81	82	83	84	85	86	87	88	89	90
91	92	93	94	95	96	97	98	99	100

1	2	3	4	5	6	7	8	9	10
11	12	13	14	15	16	17	18	19	20
21	22	23	24	25	26	27	28	29	30
31	32	33	34	35	36	37	38	39	40
41	42	43	44	45	46	47	48	49	50
51	52	53	54	55	56	57	58	59	60
61	62	63	64	65	66	67	68	69	70
71	72	73	74	75	76	77	78	79	80
81	82	83	84	85	86	87	88	89	90
91	92	93	94	95	96	97	98	99	100

1	2	3	4	5	6	7	8	9	10
11	12	13	14	15	16	17	18	19	20
21	22	23	24	25	26	27	28	29	30
31	32	33	34	35	36	37	38	39	40
41	42	43	44	45	46	47	48	49	50
51	52	53	54	55	56	57	58	59	60
61	62	63	64	65	66	67	68	69	70
71	72	73	74	75	76	77	78	79	80
81	82	83	84	85	86	87	88	89	90
91	92	93	94	95	96	97	98	99	100

1	2	3	4	5	6	7	8	9	10
11	12	13	14	15	16	17	18	19	20
21	22	23	24	25	26	27	28	29	30
31	32	33	34	35	36	37	38	39	40
41	42	43	44	45	46	47	48	49	50
51	52	53	54	55	56	57	58	59	60
61	62	63	64	65	66	67	68	69	70
71	72	73	74	75	76	77	78	79	80
81	82	83	84	85	86	87	88	89	90
91	92	93	94	95	96	97	98	99	100

1	2	3	4	5	6	7	8	9	10
11	12	13	14	15	16	17	18	19	20
21	22	23	24	25	26	27	28	29	30
31	32	33	34	35	36	37	38	39	40
41	42	43	44	45	46	47	48	49	50
51	52	53	54	55	56	57	58	59	60
61	62	63	64	65	66	67	68	69	70
71	72	73	74	75	76	77	78	79	80
81	82	83	84	85	86	87	88	89	90
91	92	93	94	95	96	97	98	99	100

1	2	3	4	5	6	7	8	9	10
11	12	13	14	15	16	17	18	19	20
21	22	23	24	25	26	27	28	29	30
31	32	33	34	35	36	37	38	39	40
41	42	43	44	45	46	47	48	49	50
51	52	53	54	55	56	57	58	59	60
61	62	63	64	65	66	67	68	69	70
71	72	73	74	75	76	77	78	79	80
81	82	83	84	85	86	87	88	89	90
91	92	93	94	95	96	97	98	99	100

THIS PAGE IS LEFT BLANK

# UNIT 7 DATA AND PROBABILITY

## BLM 1 Fraction Circles for Spinners

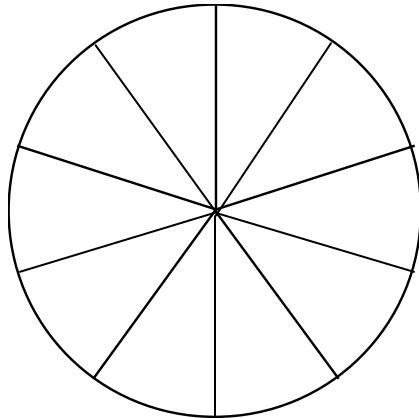
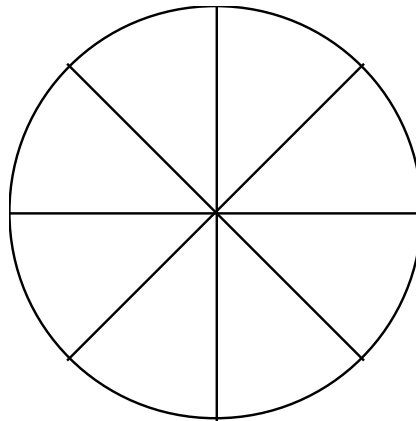
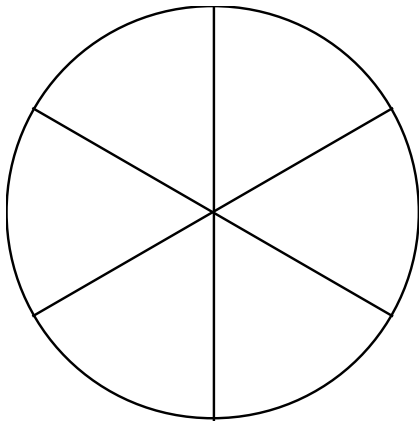
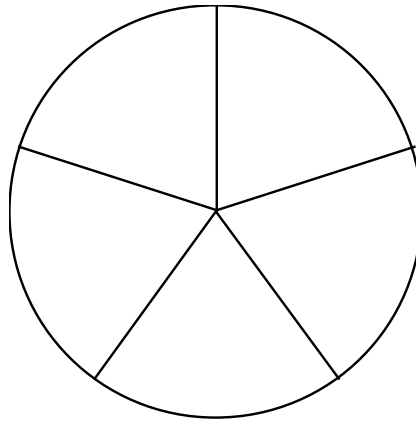
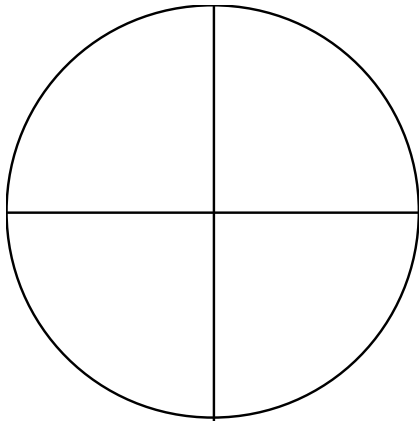
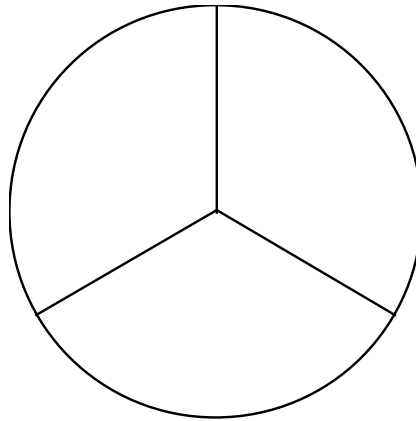
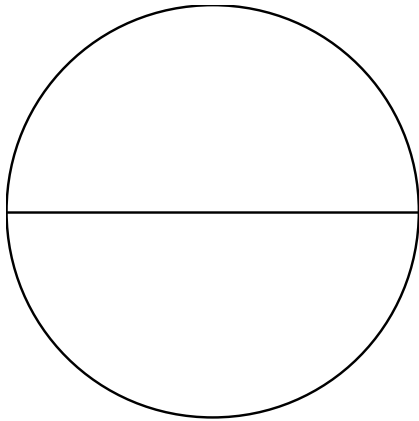

THIS PAGE IS LEFT BLANK