

Mathematics Blackline Masters for Class VI

For use during teaching-learning process

Student Name: _____

School: _____



Department of School Education
Ministry of Education and Skills Development
Thimphu

UNIT 1 FRACTIONS AND DECIMALS

BLM 1 Fraction Match Game Cards

| | | | | | |
|----------------|-----------------------------|----------------|-----------------------------|--------------------------------|-----------------------------|
| $\frac{1}{2}$ | 0.35 | $1\frac{2}{3}$ | $\frac{2}{5} + \frac{2}{5}$ | $\frac{12}{3}$ | 0.23 |
| 4 | $\frac{4}{5}$ | $\frac{4}{6}$ | $\frac{5}{3}$ | $3\frac{3}{4}$ | $\frac{4}{8}$ |
| $\frac{5}{8}$ | $4\frac{1}{2}$ | 0.5 | $\frac{9}{2}$ | $\frac{2}{8} + \frac{3}{8}$ | 0.6 |
| $\frac{15}{4}$ | $\frac{7}{8} - \frac{3}{8}$ | $\frac{6}{10}$ | $\frac{23}{100}$ | $\frac{3}{10} + \frac{5}{100}$ | $\frac{5}{6} - \frac{1}{6}$ |

THIS PAGE IS LEFT BLANK

BLM 2 Fraction Strips

| | | | | | | | | | | | |
|----------------|----------------|----------------|----------------|----------------|----------------|----------------|----------------|----------------|----------------|----------------|----------------|
| 1 | | | | | | | | | | | |
| $\frac{1}{2}$ | | | | | | $\frac{1}{2}$ | | | | | |
| $\frac{1}{3}$ | | | | $\frac{1}{3}$ | | | | $\frac{1}{3}$ | | | |
| $\frac{1}{4}$ | | | $\frac{1}{4}$ | | | $\frac{1}{4}$ | | | $\frac{1}{4}$ | | |
| $\frac{1}{5}$ | | $\frac{1}{5}$ | | $\frac{1}{5}$ | | $\frac{1}{5}$ | | $\frac{1}{5}$ | | $\frac{1}{5}$ | |
| $\frac{1}{6}$ | | $\frac{1}{6}$ | | $\frac{1}{6}$ | | $\frac{1}{6}$ | | $\frac{1}{6}$ | | $\frac{1}{6}$ | |
| $\frac{1}{8}$ | $\frac{1}{8}$ | $\frac{1}{8}$ | $\frac{1}{8}$ | $\frac{1}{8}$ | $\frac{1}{8}$ | $\frac{1}{8}$ | $\frac{1}{8}$ | $\frac{1}{8}$ | $\frac{1}{8}$ | $\frac{1}{8}$ | $\frac{1}{8}$ |
| $\frac{1}{9}$ | $\frac{1}{9}$ | $\frac{1}{9}$ | $\frac{1}{9}$ | $\frac{1}{9}$ | $\frac{1}{9}$ | $\frac{1}{9}$ | $\frac{1}{9}$ | $\frac{1}{9}$ | $\frac{1}{9}$ | $\frac{1}{9}$ | $\frac{1}{9}$ |
| $\frac{1}{10}$ | $\frac{1}{10}$ | $\frac{1}{10}$ | $\frac{1}{10}$ | $\frac{1}{10}$ | $\frac{1}{10}$ | $\frac{1}{10}$ | $\frac{1}{10}$ | $\frac{1}{10}$ | $\frac{1}{10}$ | $\frac{1}{10}$ | $\frac{1}{10}$ |
| $\frac{1}{12}$ | $\frac{1}{12}$ | $\frac{1}{12}$ | $\frac{1}{12}$ | $\frac{1}{12}$ | $\frac{1}{12}$ | $\frac{1}{12}$ | $\frac{1}{12}$ | $\frac{1}{12}$ | $\frac{1}{12}$ | $\frac{1}{12}$ | $\frac{1}{12}$ |

THIS PAGE IS LEFT BLANK

BLM 3 Pattern Block Fraction Pieces

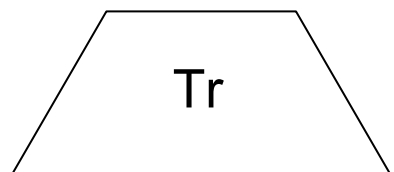
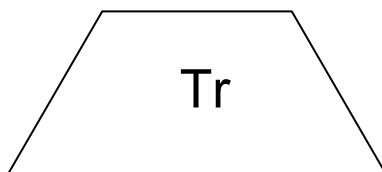
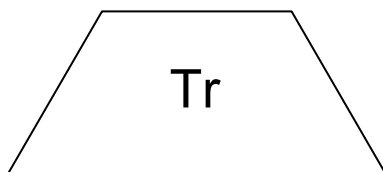
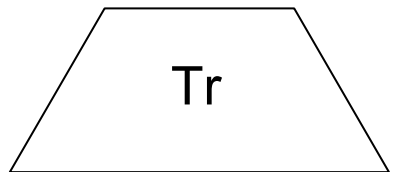
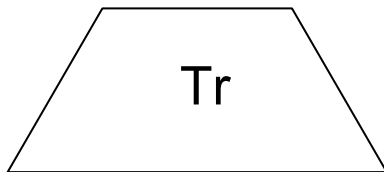
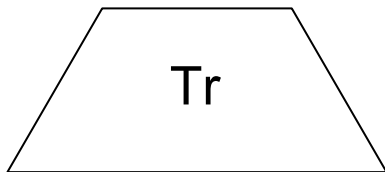
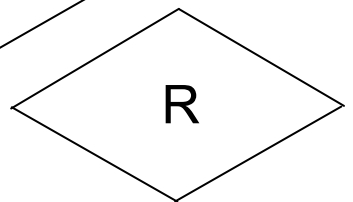
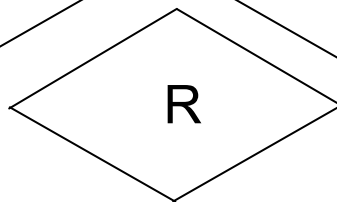
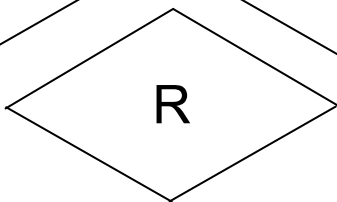
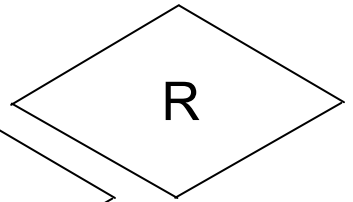
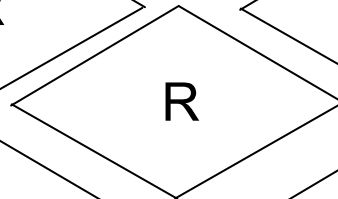
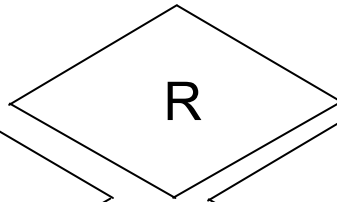
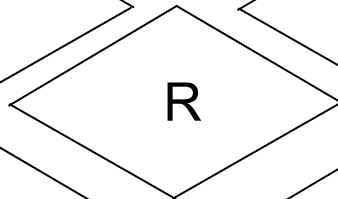
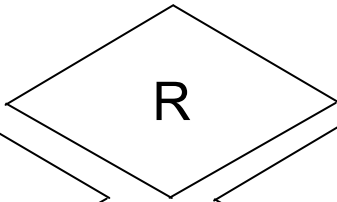
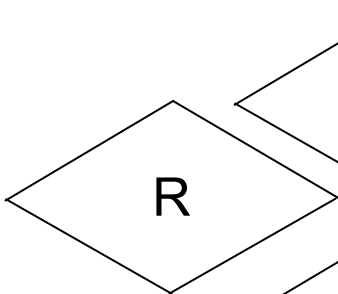
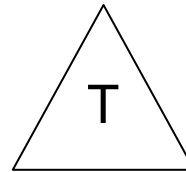
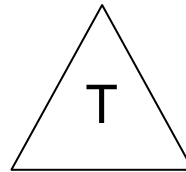
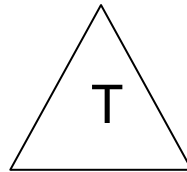
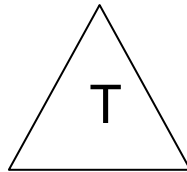
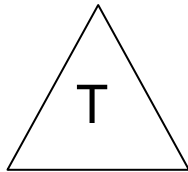
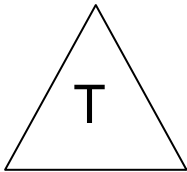
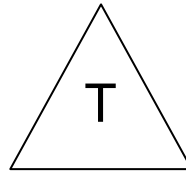
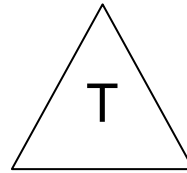
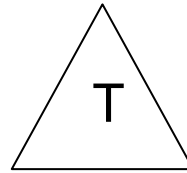
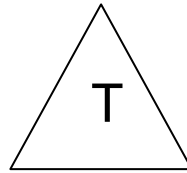
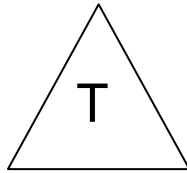
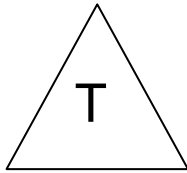
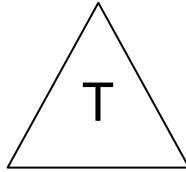
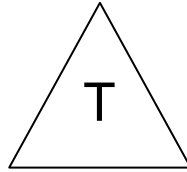
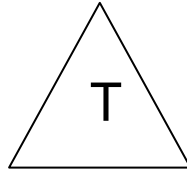
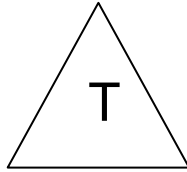
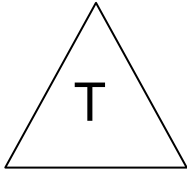
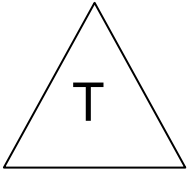
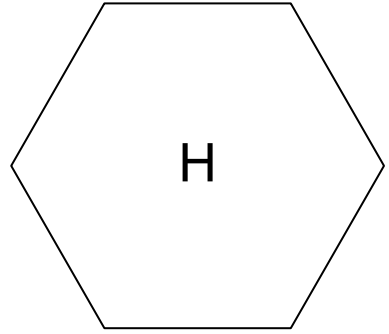
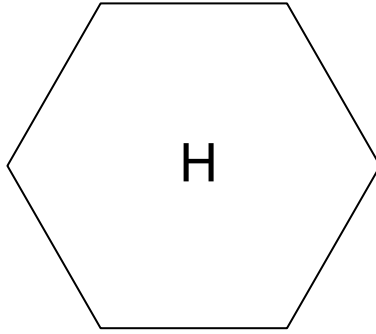
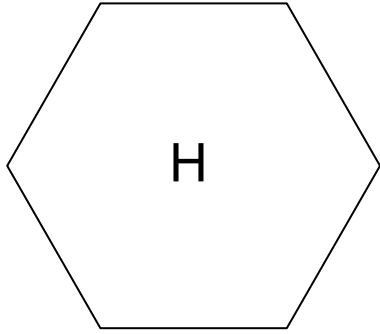

THIS PAGE IS LEFT BLANK

BLM 4 Hundredths Grids

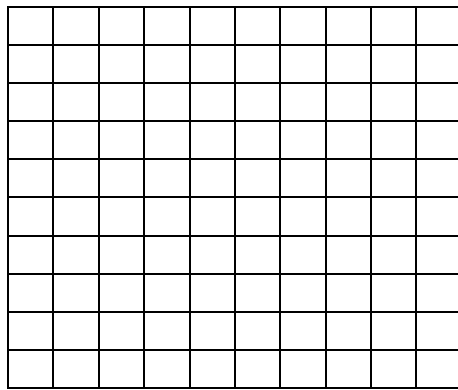
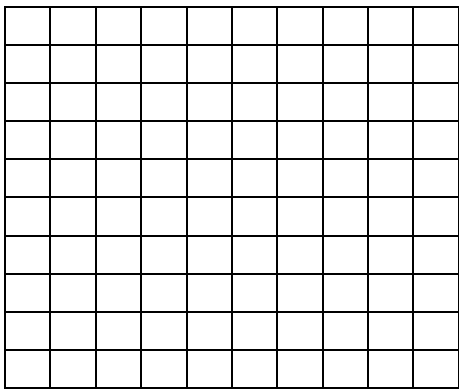
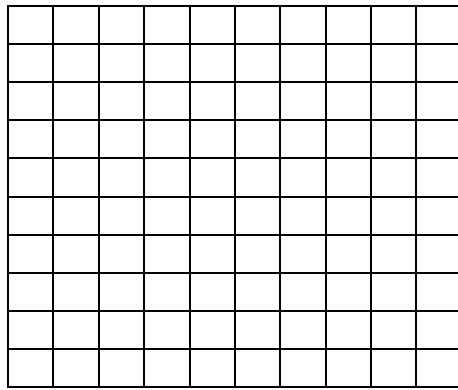
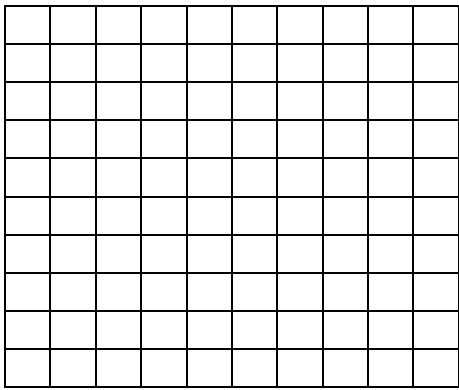
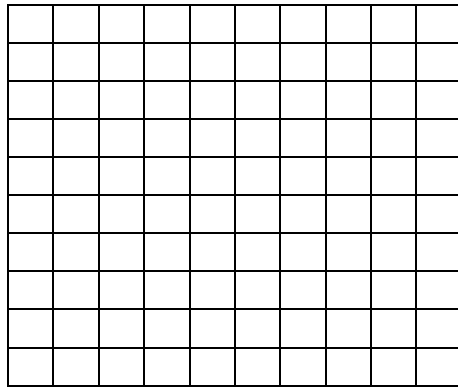
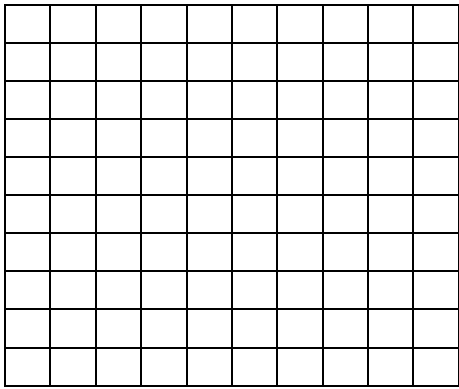
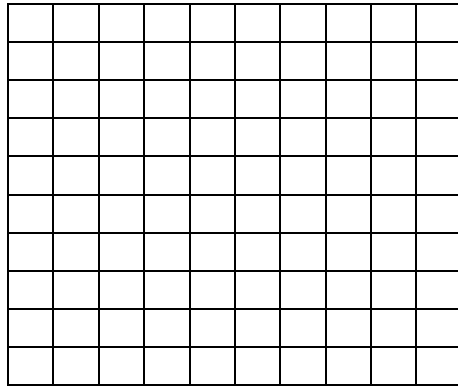
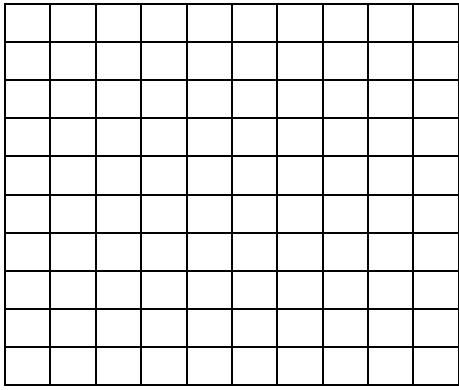

THIS PAGE IS LEFT BLANK

BLM 5 Small Grid Paper

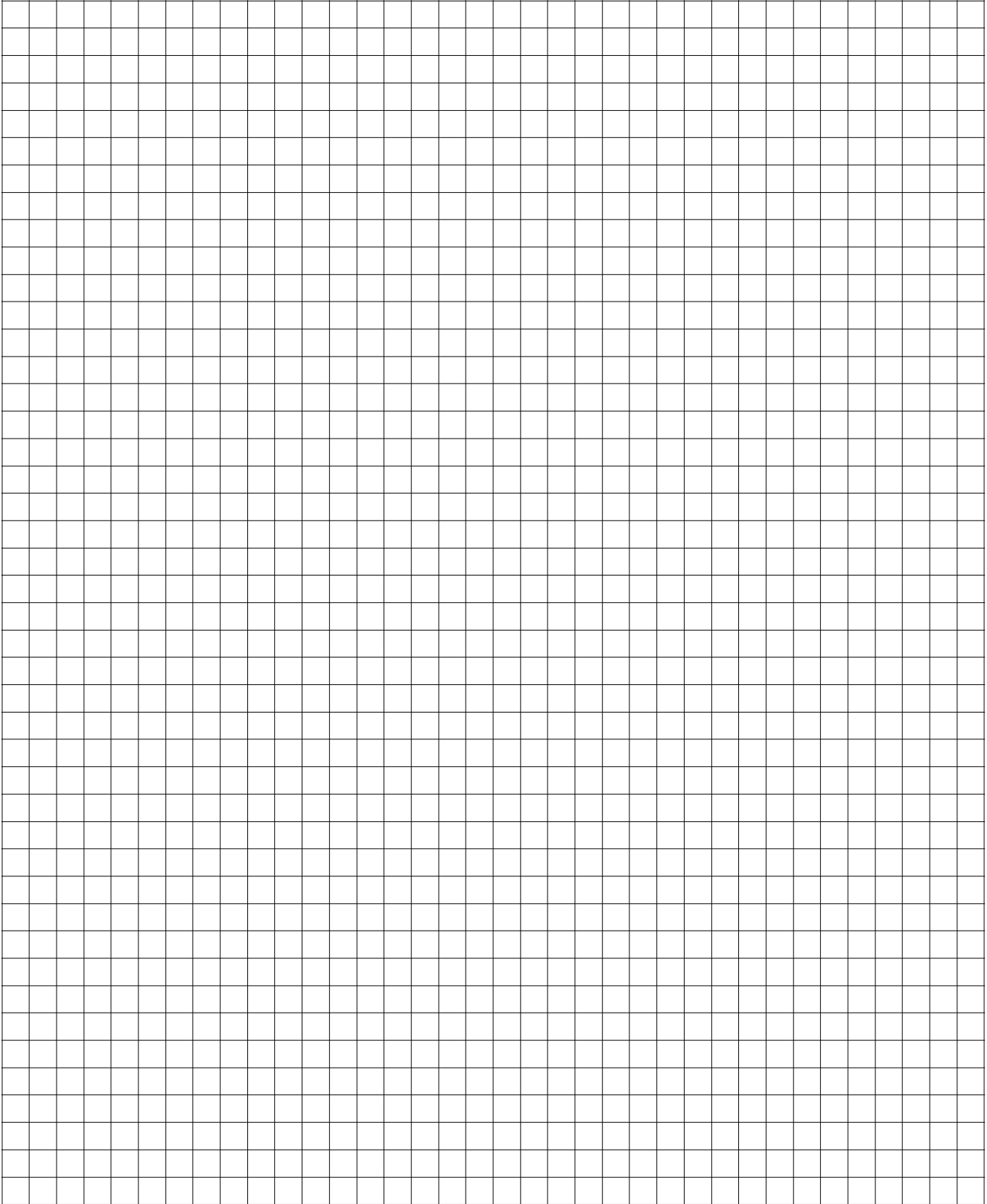

THIS PAGE IS LEFT BLANK

UNIT 2 GEOMETRY

BLM 1 Tessellating Shapes

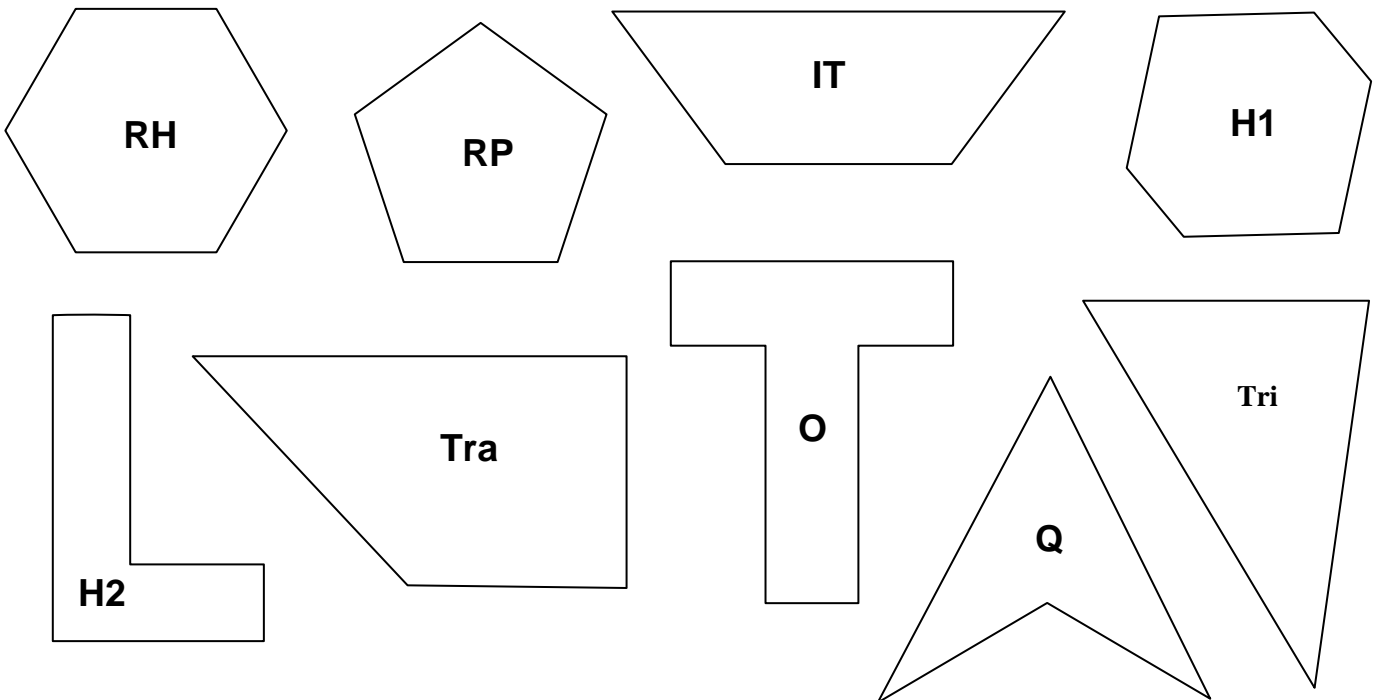
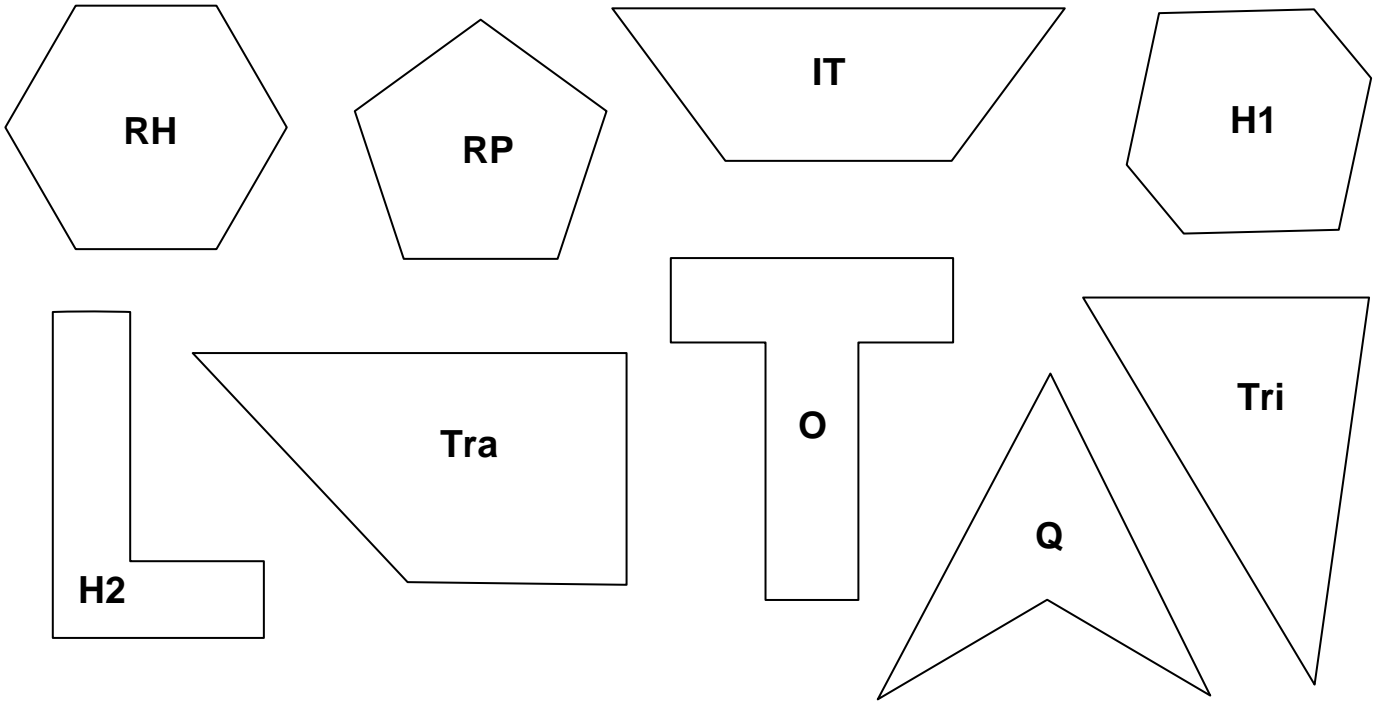

THIS PAGE IS LEFT BLANK

BLM 2 Paper Protractors

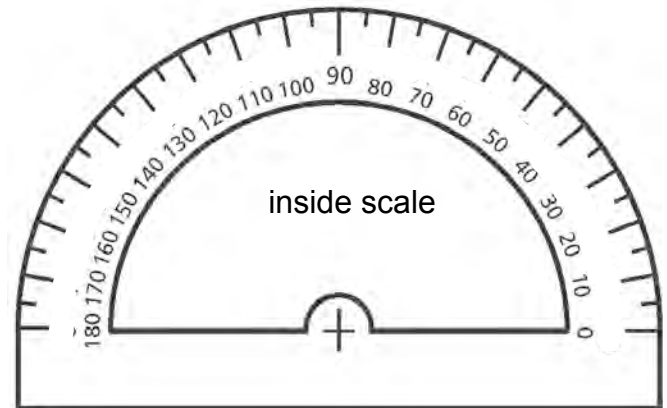
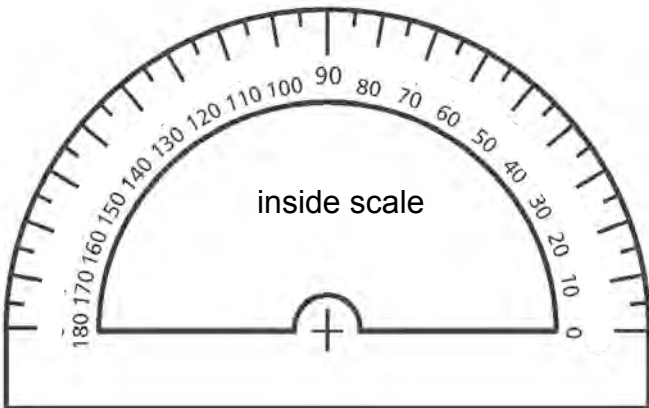
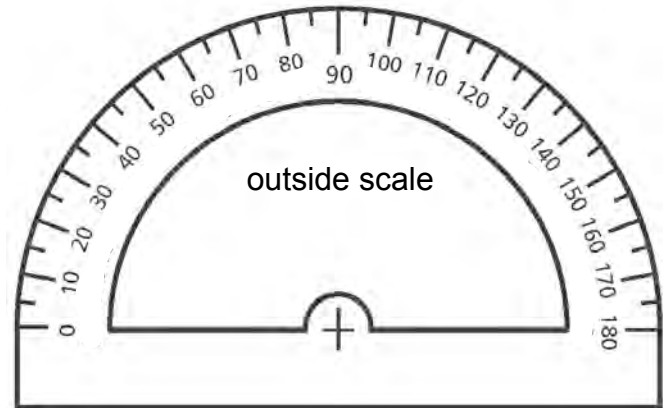
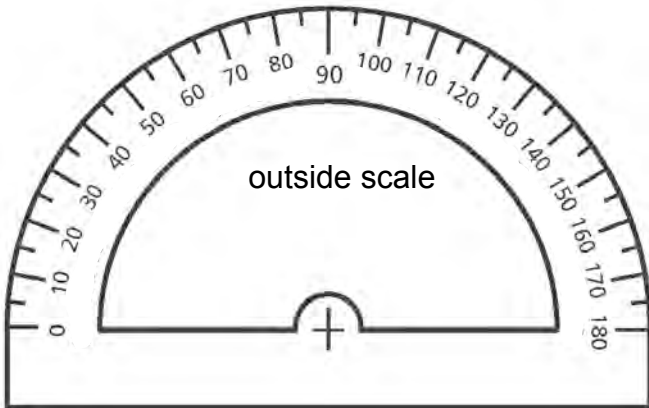
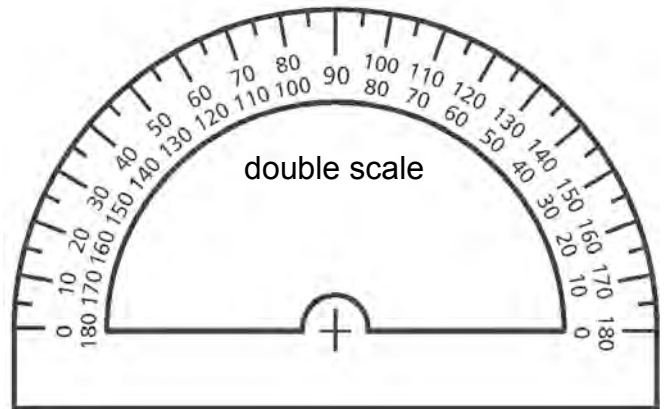
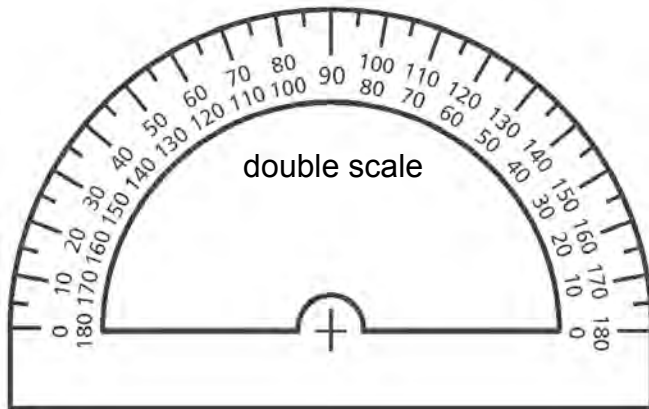
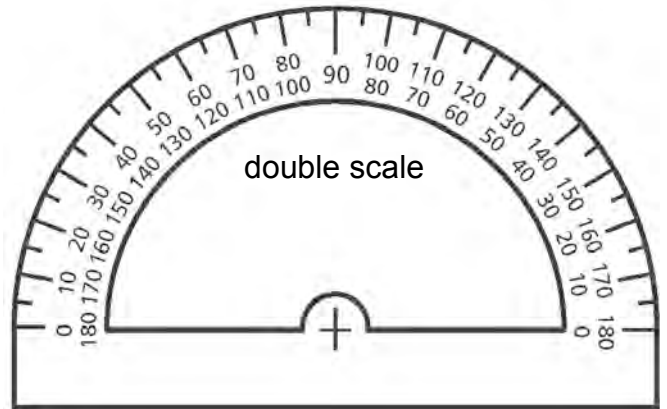
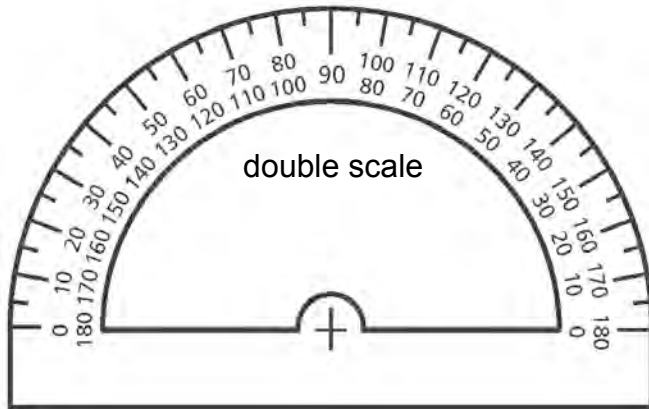

THIS PAGE IS LEFT BLANK

BLM 3 Field Angles



THIS PAGE IS LEFT BLANK

BLM 4 Angle Bisectors

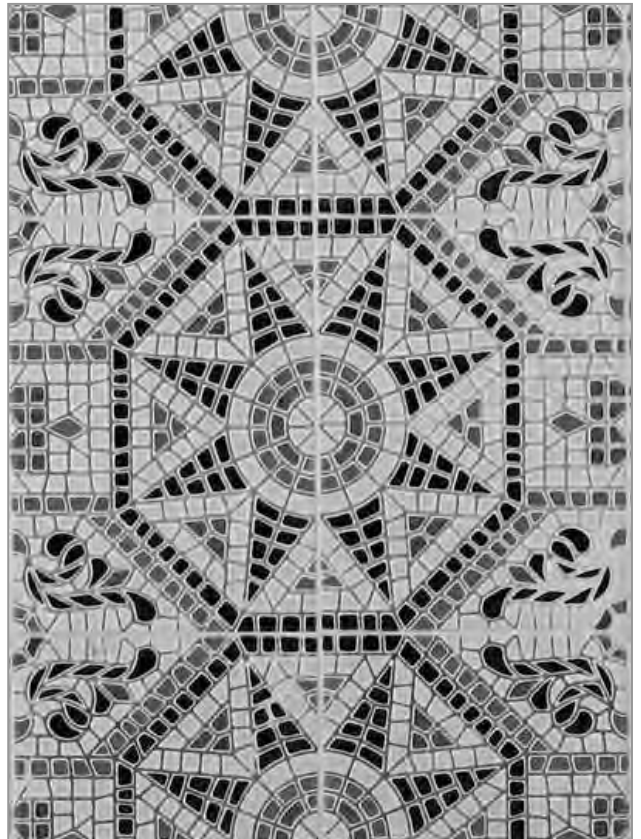
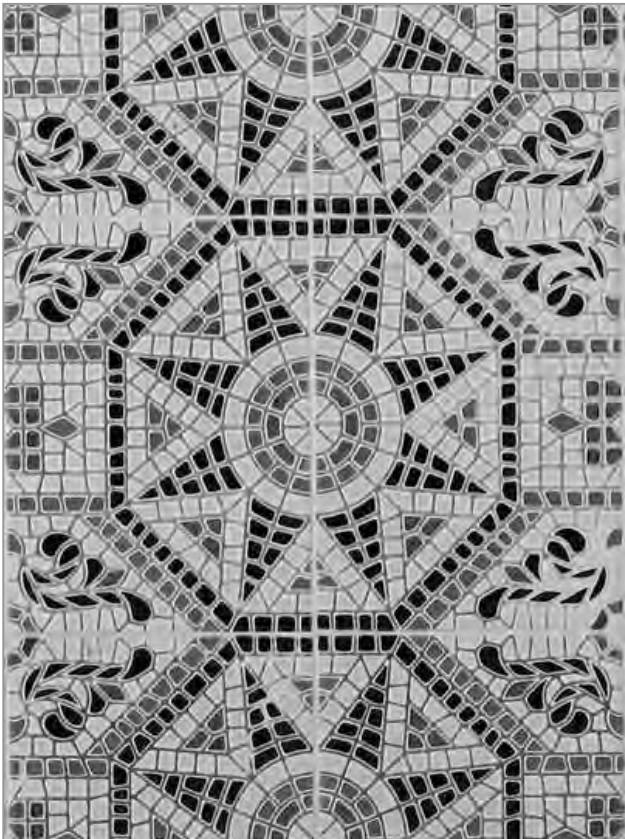
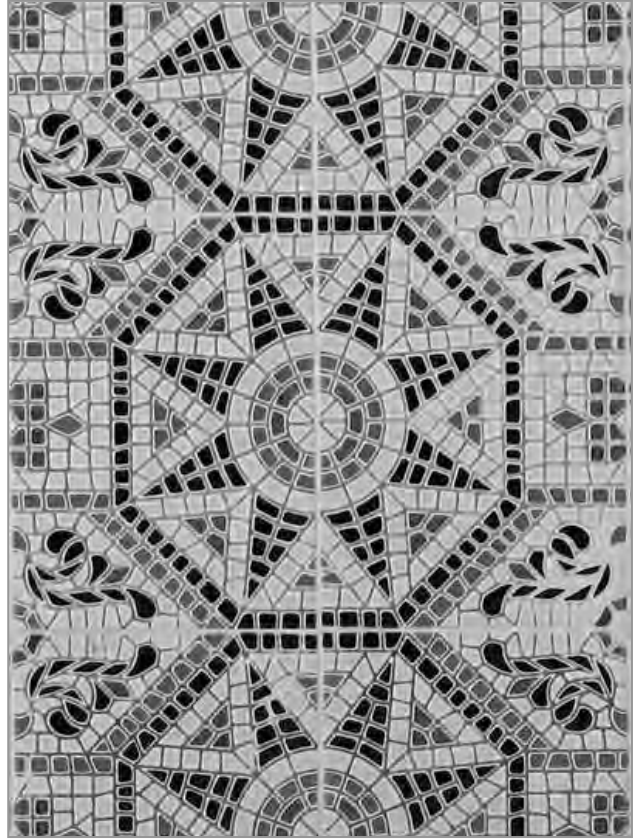
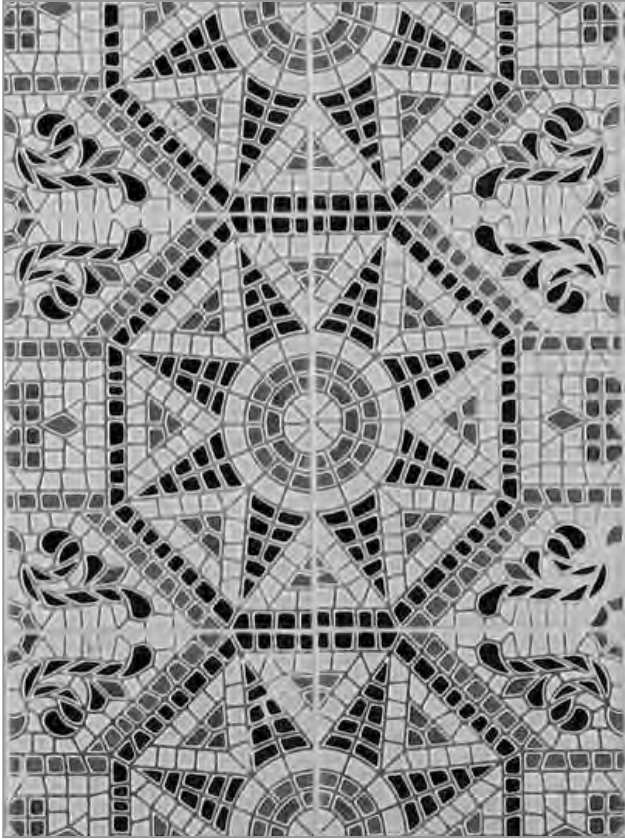

THIS PAGE IS LEFT BLANK

BLM 5 Sorting Quadrilaterals

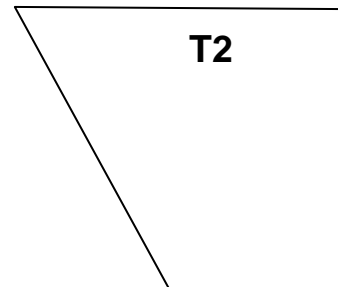
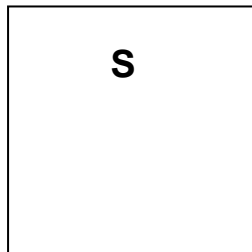
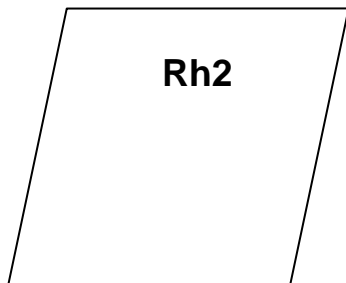
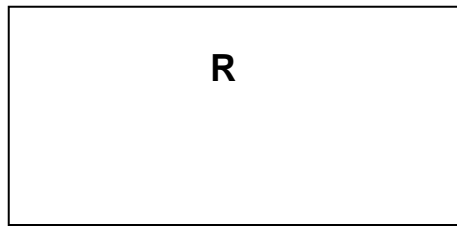
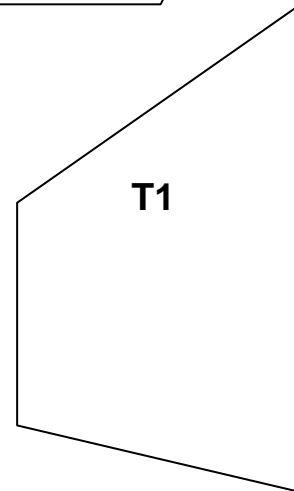
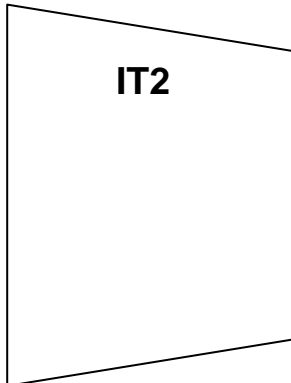
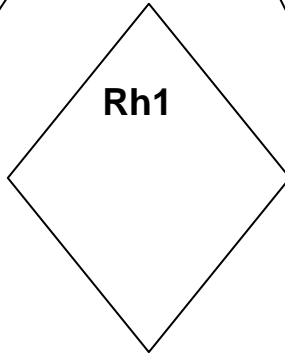
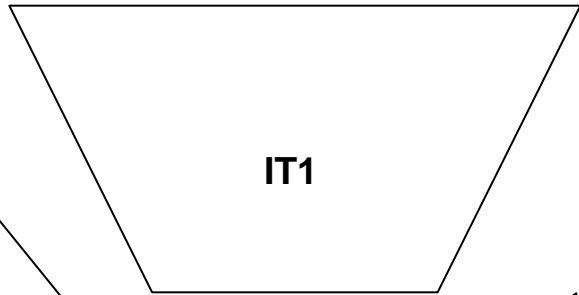
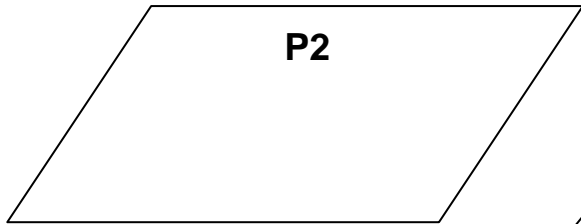
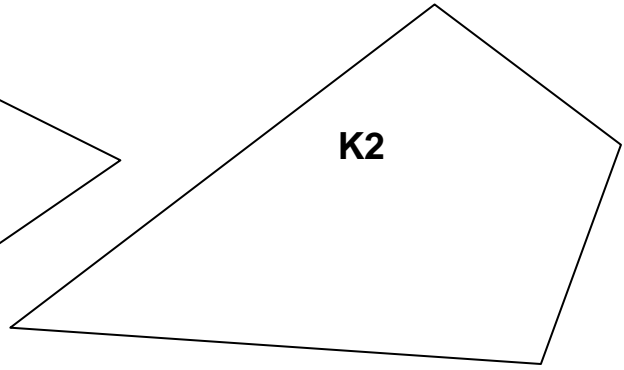
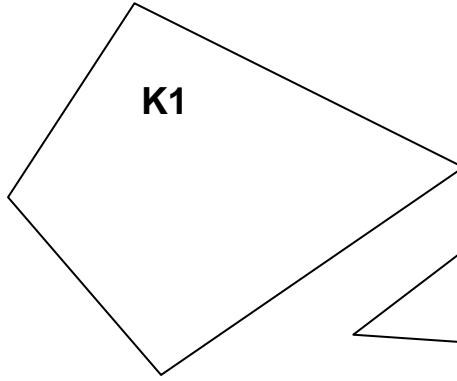
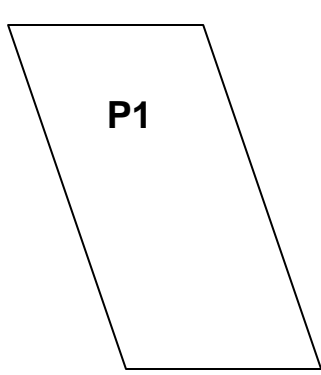

THIS PAGE IS LEFT BLANK

BLM 6 Go Fish Game Cards

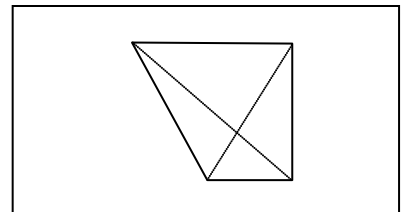
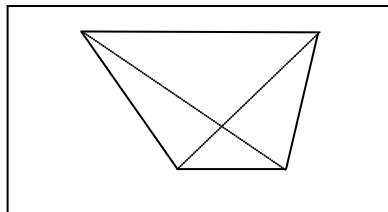
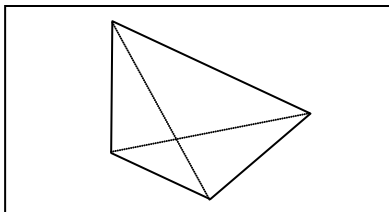
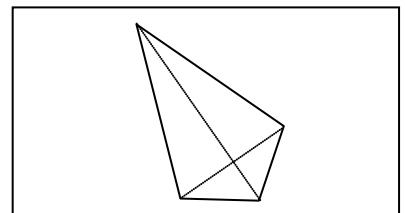
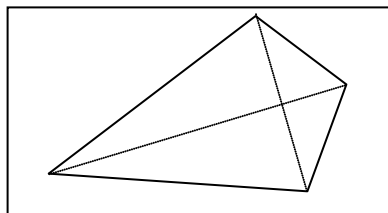
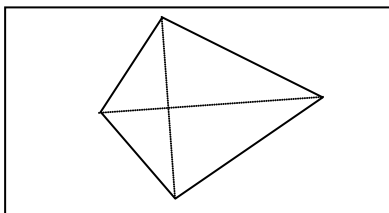
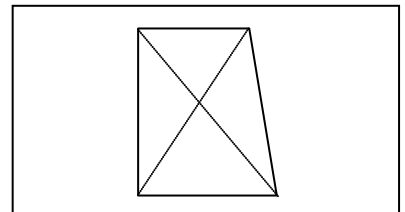
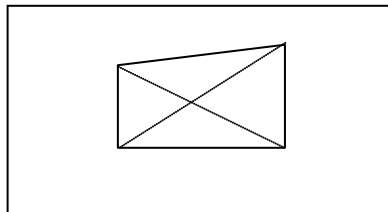
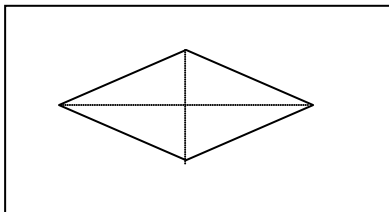
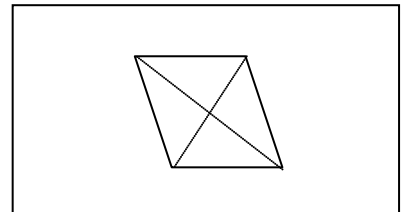
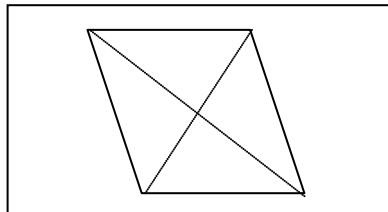
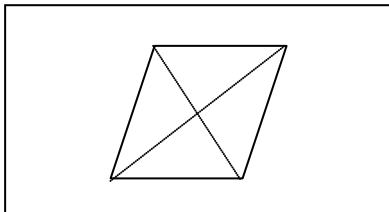
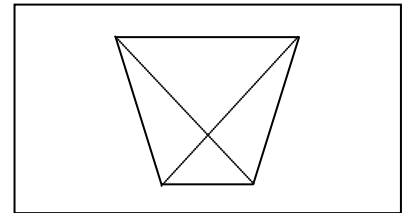
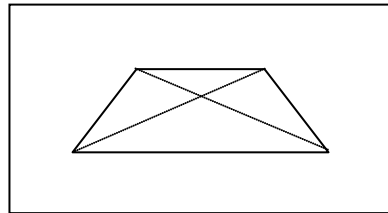
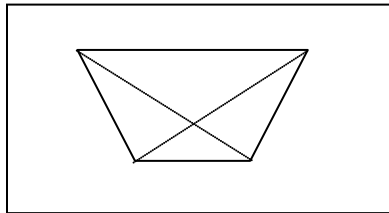
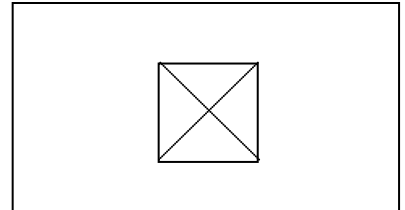
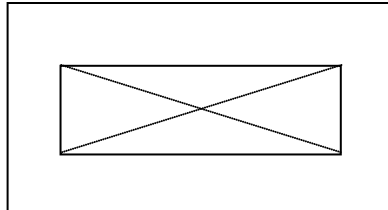
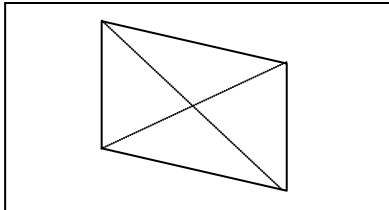
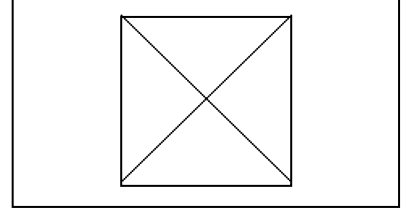
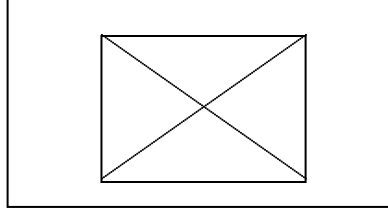
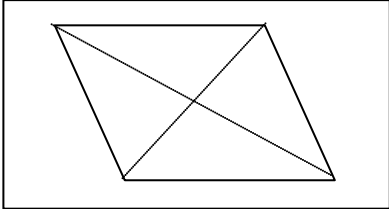
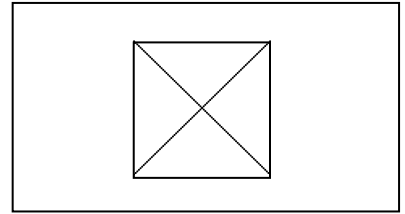
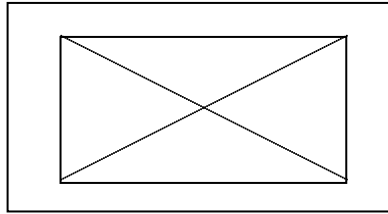
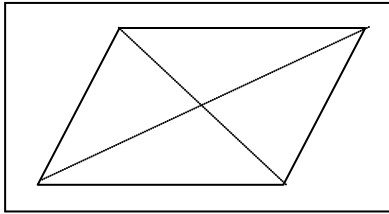

THIS PAGE IS LEFT BLANK

BLM 7 Sample Net of Cube

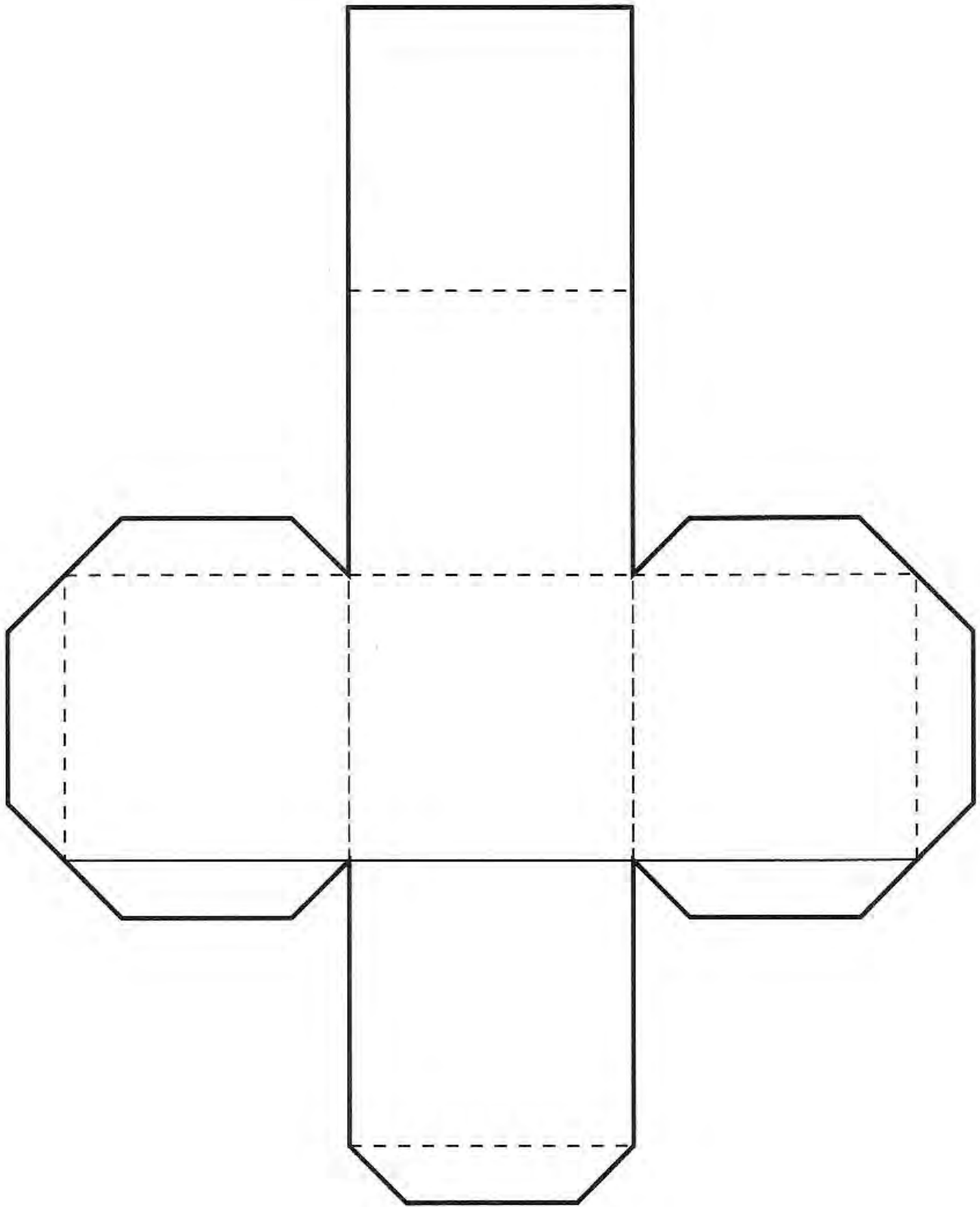

THIS PAGE IS LEFT BLANK

BLM 8 Sample Net of Right Triangle-based Prism

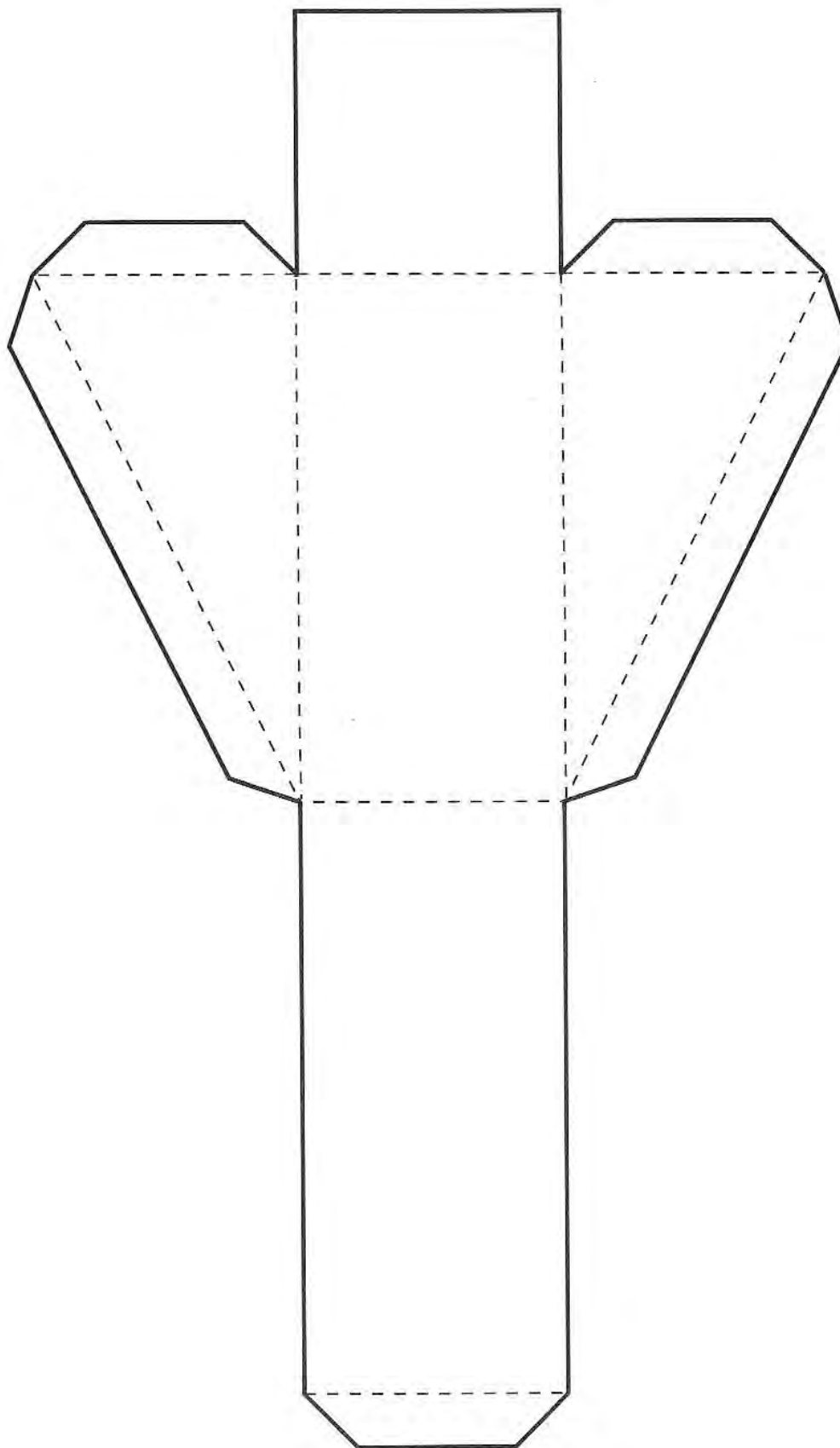

THIS PAGE IS LEFT BLANK

BLM 9 Sample Net of Rectangle-based Prism

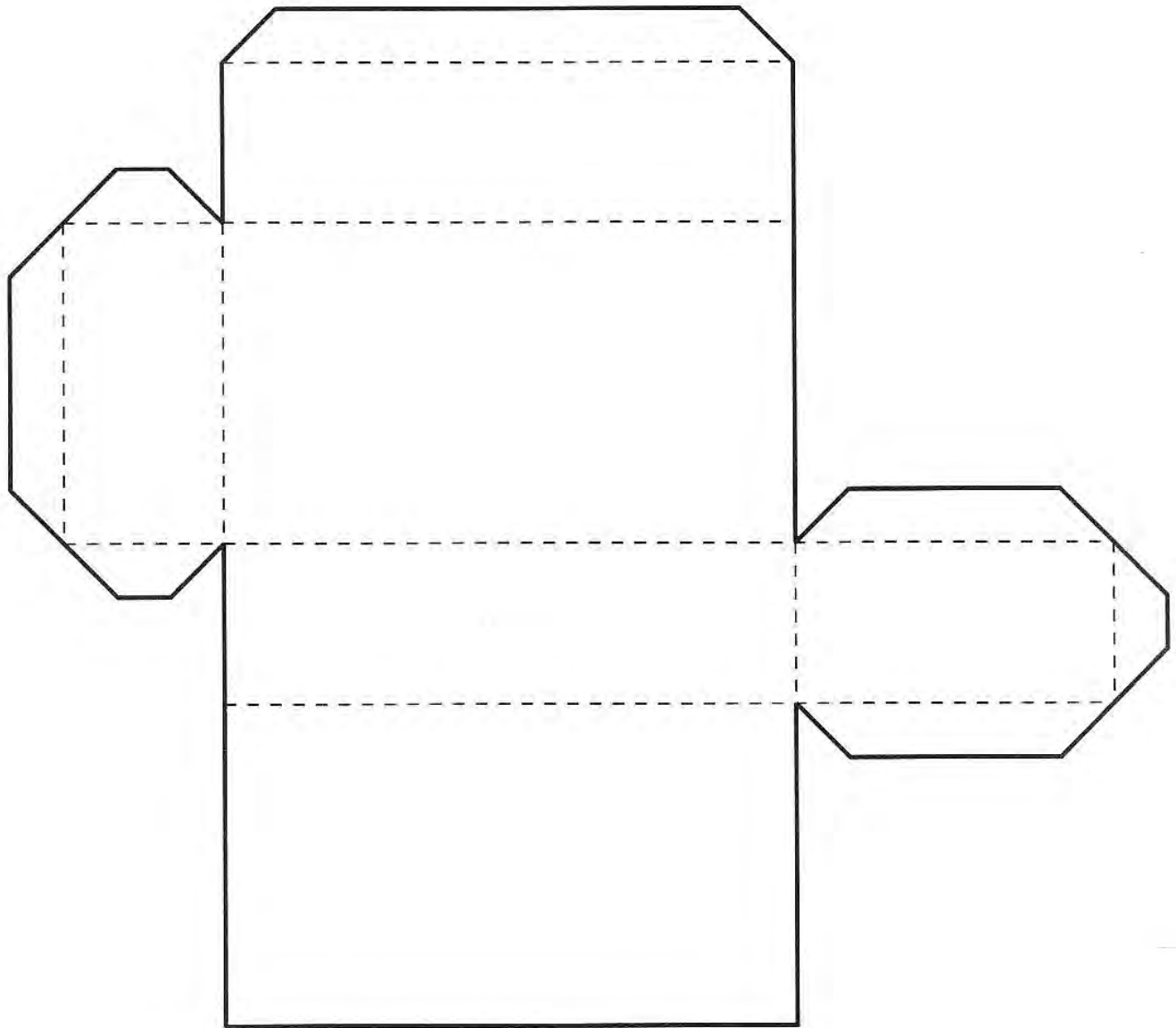

THIS PAGE IS LEFT BLANK

BLM 10 Sample Net of Square-based Pyramid

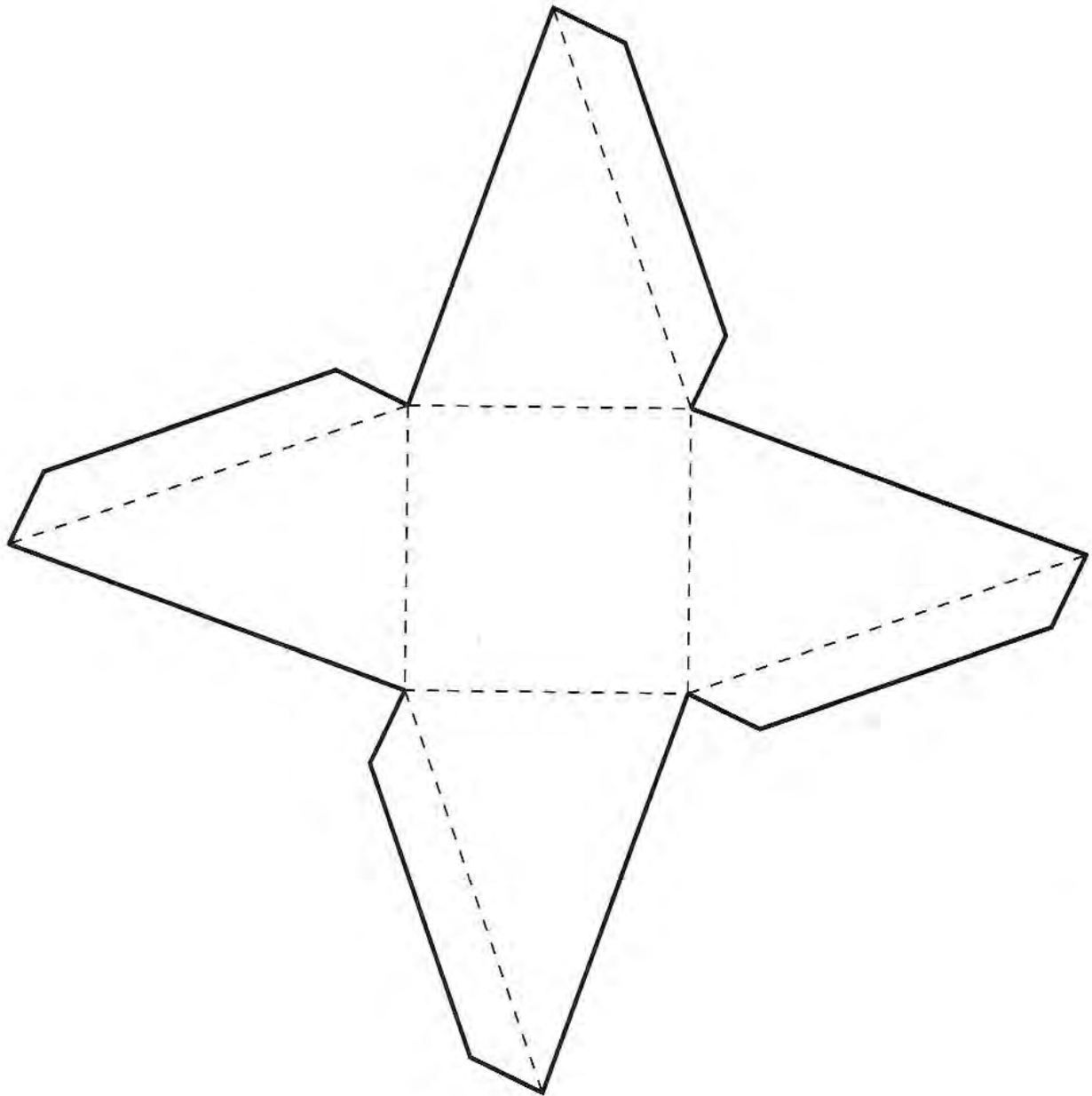

THIS PAGE IS LEFT BLANK

BLM 11 Sample Net of Regular Hexagon-based Prism

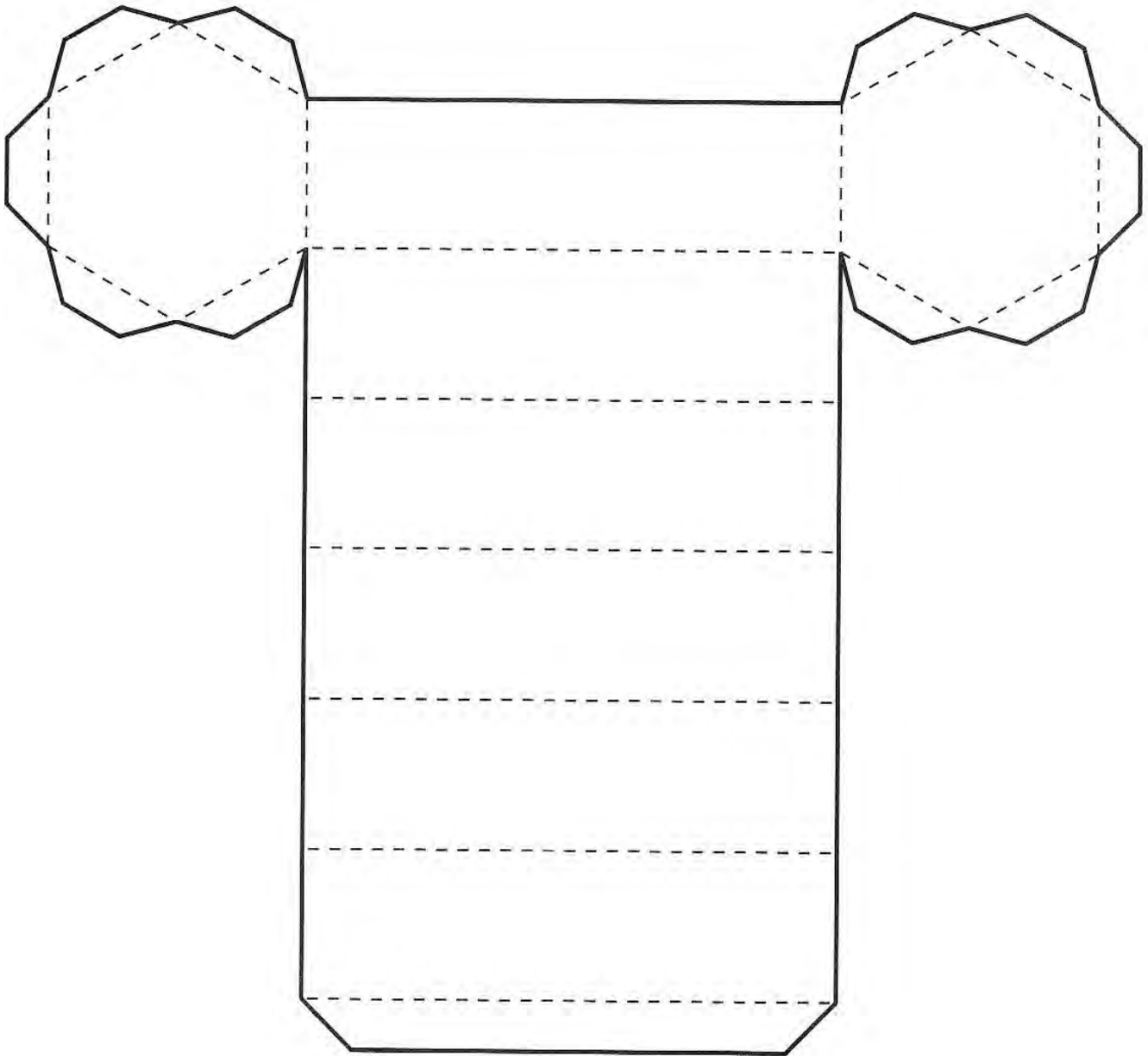

THIS PAGE IS LEFT BLANK

BLM 12 Grid Paper (1 cm by 1 cm)

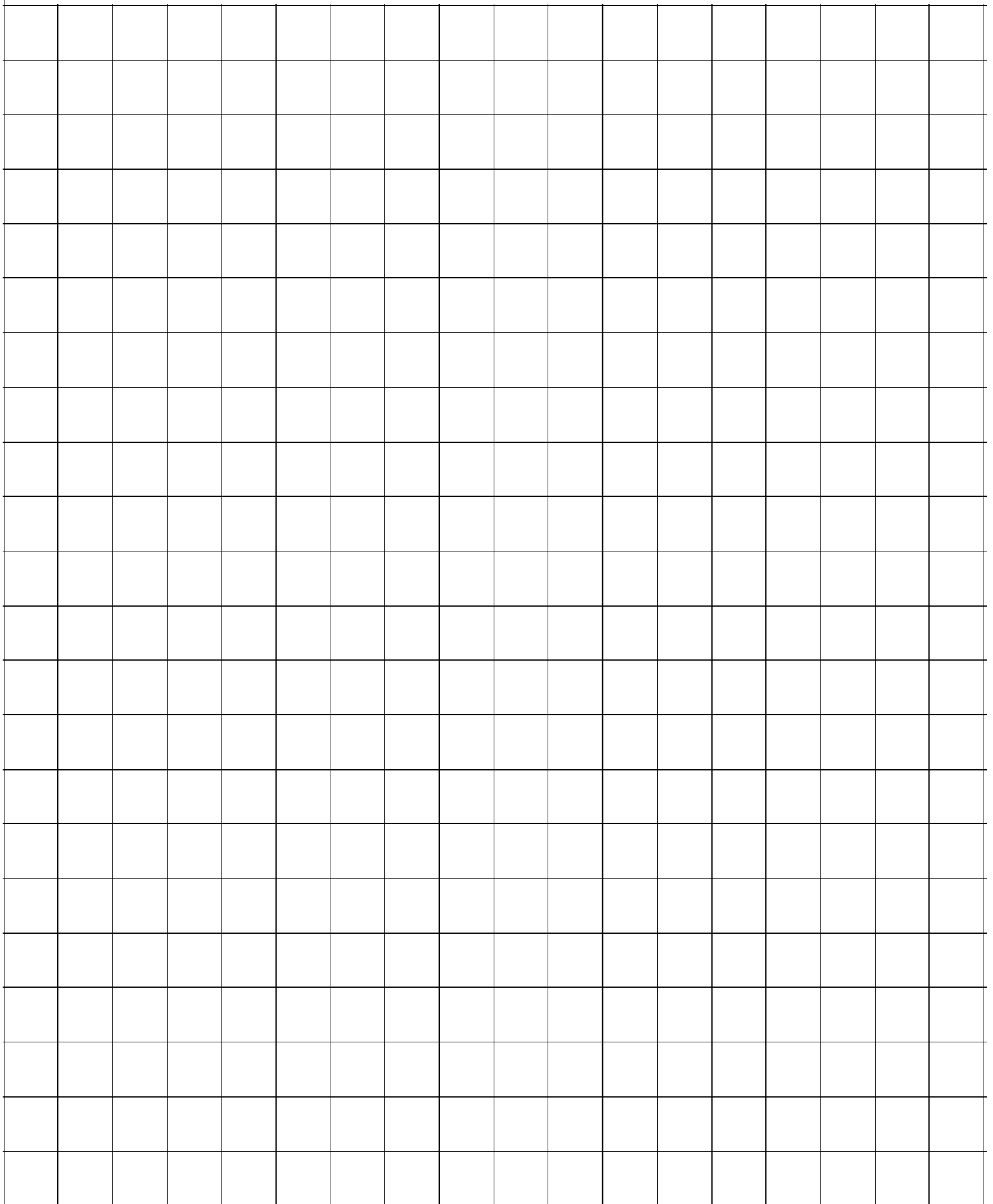

THIS PAGE IS LEFT BLANK

UNIT 3 DECIMAL COMPUTATION

BLM 1 Place Value Charts I

| Tens | Ones | Tenths | Hundredths | Thousandths |
|------|------|--------|------------|-------------|
| | | | | |
| | | | | |
| | | | | |

| Tens | Ones | Tenths | Hundredths | Thousandths |
|------|------|--------|------------|-------------|
| | | | | |
| | | | | |
| | | | | |

| Tens | Ones | Tenths | Hundredths | Thousandths |
|------|------|--------|------------|-------------|
| | | | | |
| | | | | |
| | | | | |

| Tens | Ones | Tenths | Hundredths | Thousandths |
|------|------|--------|------------|-------------|
| | | | | |
| | | | | |
| | | | | |

| Tens | Ones | Tenths | Hundredths | Thousandths |
|------|------|--------|------------|-------------|
| | | | | |
| | | | | |
| | | | | |

| Tens | Ones | Tenths | Hundredths | Thousandths |
|------|------|--------|------------|-------------|
| | | | | |
| | | | | |
| | | | | |

| Tens | Ones | Tenths | Hundredths | Thousandths |
|------|------|--------|------------|-------------|
| | | | | |
| | | | | |
| | | | | |

| Tens | Ones | Tenths | Hundredths | Thousandths |
|------|------|--------|------------|-------------|
| | | | | |
| | | | | |
| | | | | |

THIS PAGE IS LEFT BLANK

BLM 2A Base Ten Models (Hundreds, Tens, and Ones)

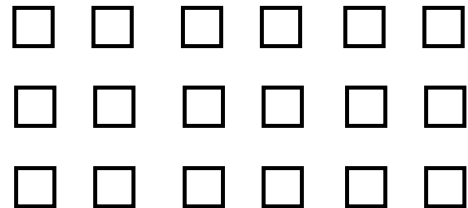
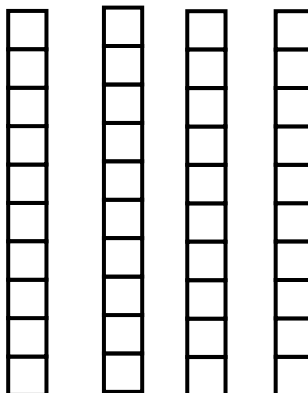
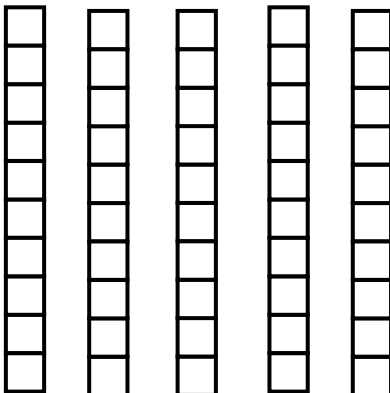
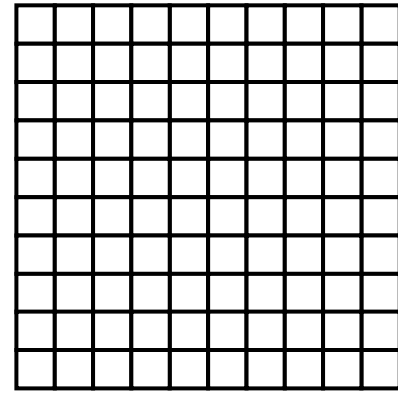
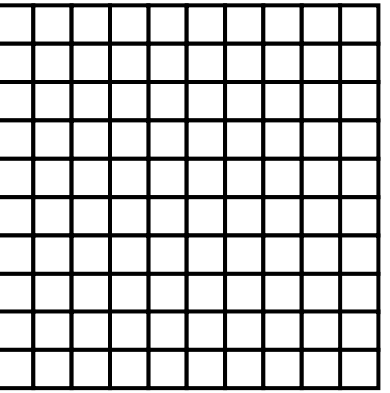
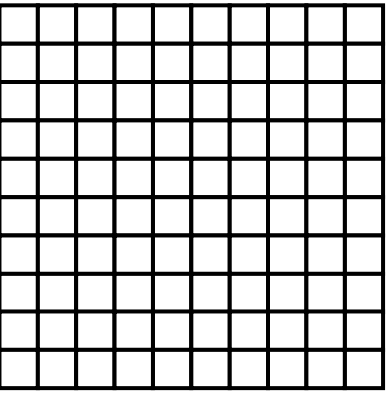
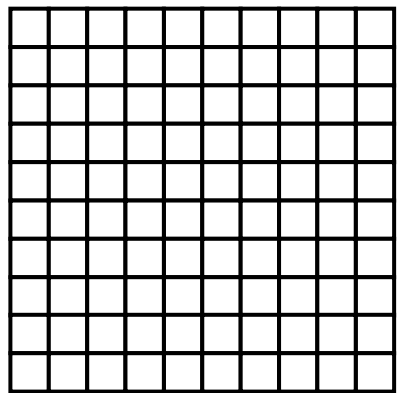
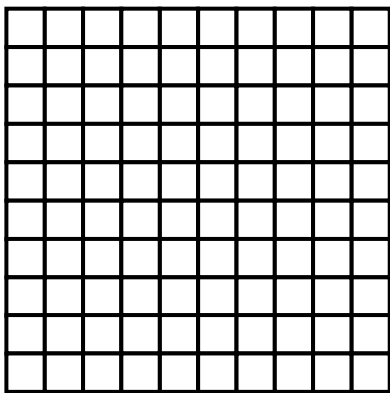
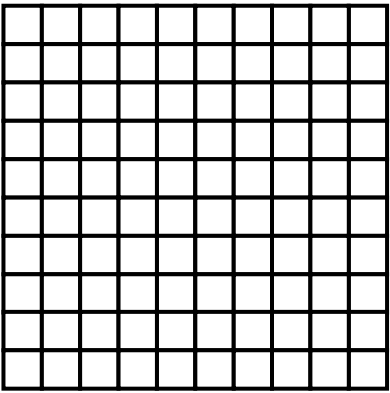
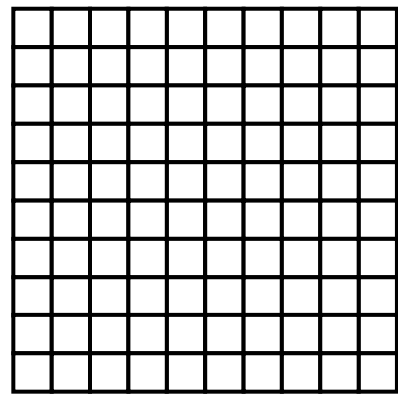
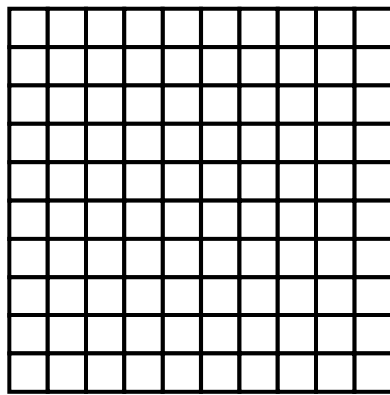
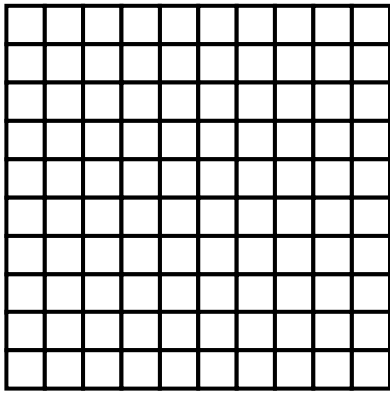

THIS PAGE IS LEFT BLANK

BLM 2B Base Ten Models (Thousands)

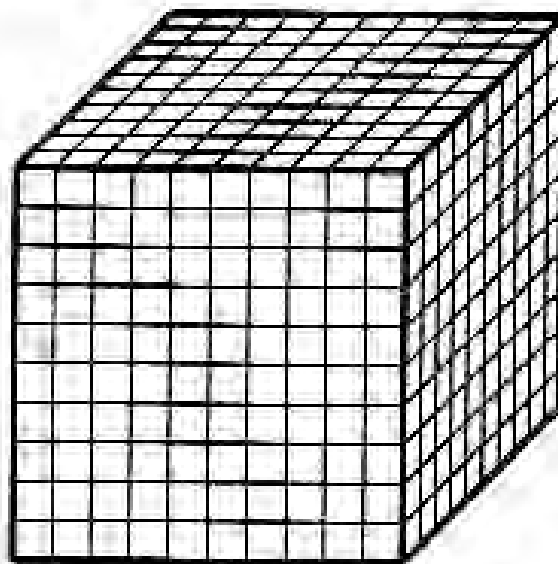
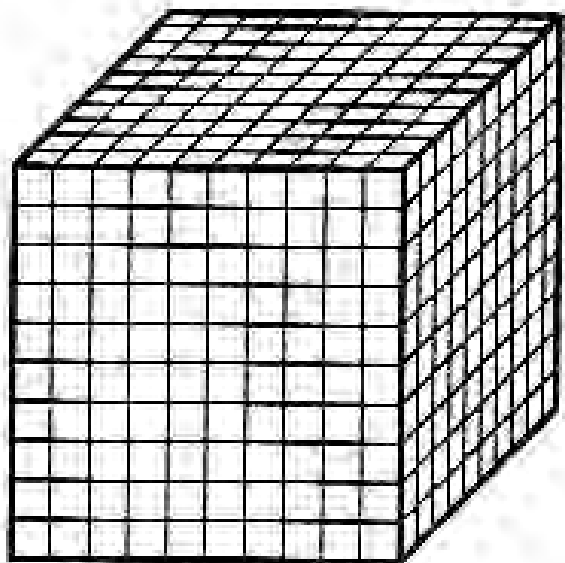
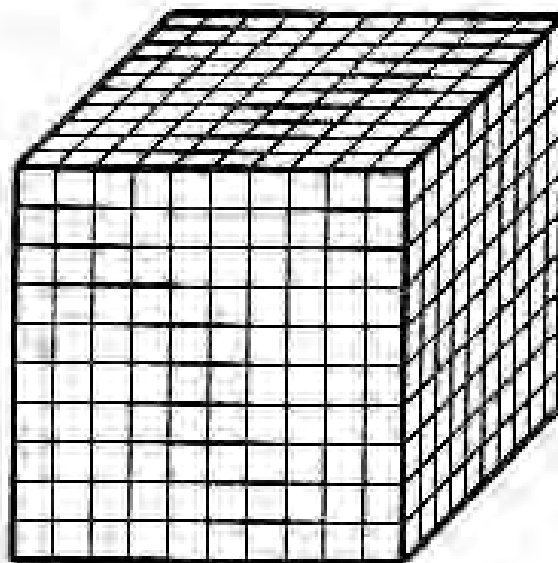
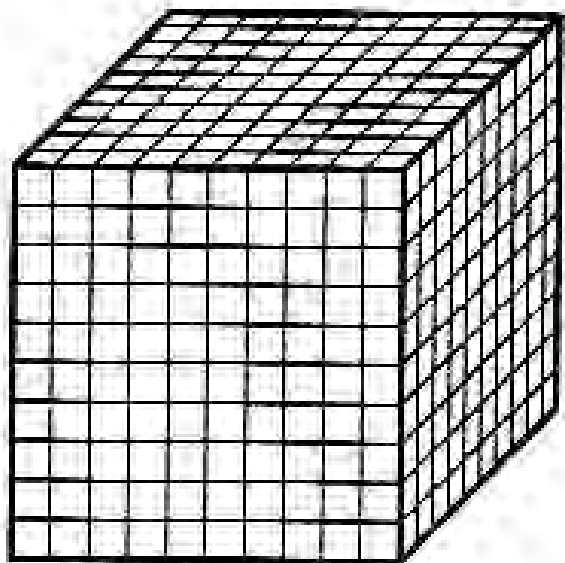
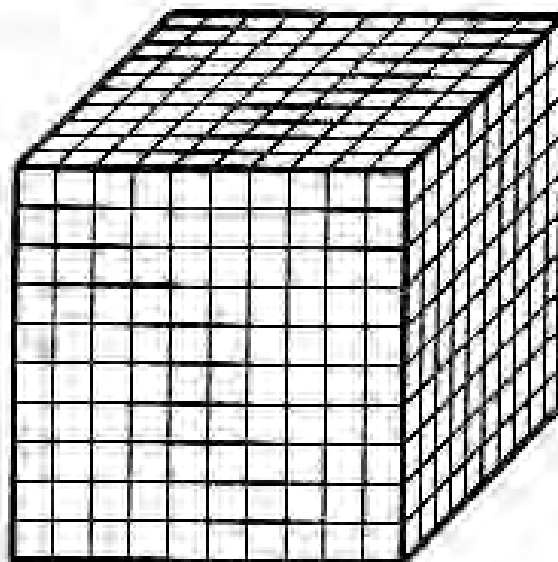
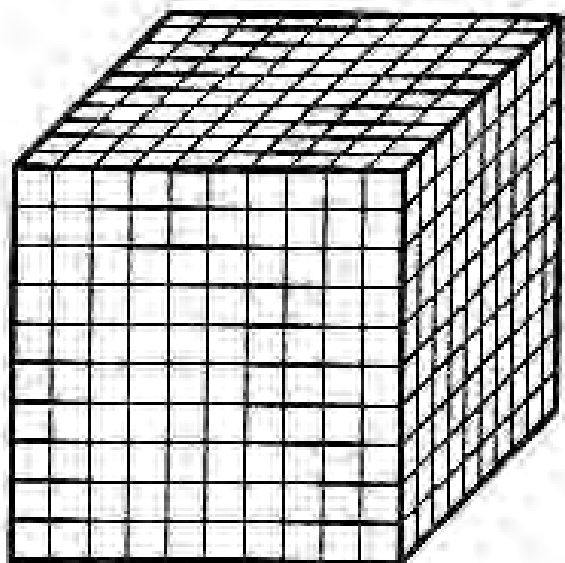

THIS PAGE IS LEFT BLANK

UNIT 4 MEASUREMENT

BLM 1 Square Dot Grid Paper

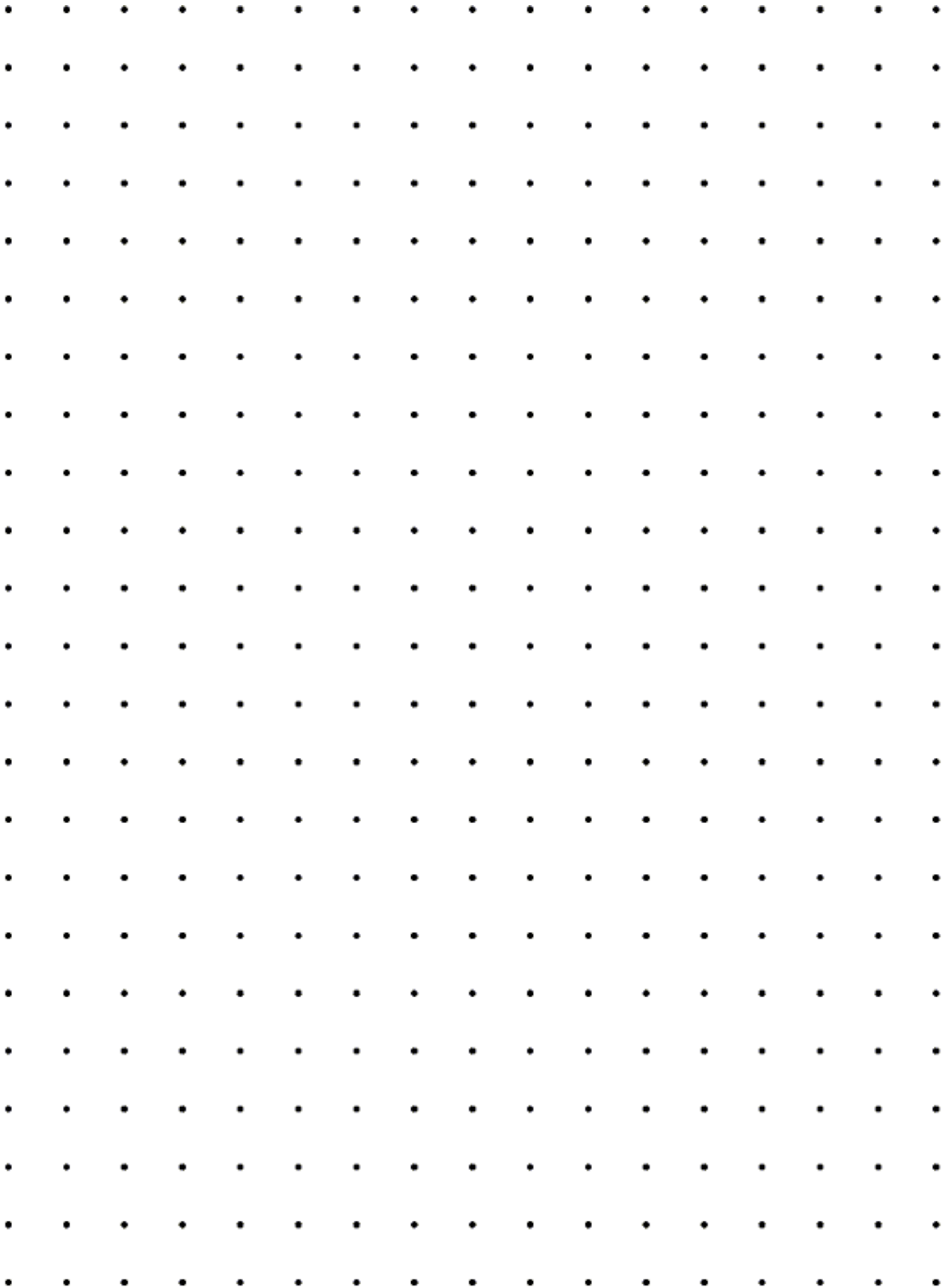

THIS PAGE IS LEFT BLANK

UNIT 5 RATIO, RATE, AND PERCENT

BLM 1 Getting Started Squares

| | | | | | | |
|--|--|--|--|--|--|--|
| | | | | | | |
| | | | | | | |
| | | | | | | |
| | | | | | | |
| | | | | | | |
| | | | | | | |
| | | | | | | |
| | | | | | | |
| | | | | | | |
| | | | | | | |

THIS PAGE IS LEFT BLANK

BLM 2 Ratio Match Game Cards

| | | | | | |
|---------------|----------------|-------|----------------|---------------|---------------|
| 2 : 4 | 0.75 | 16% | 0.33 | 0.40 | 10% |
| 1 : 10 | 0.23 | 80% | $\frac{2}{5}$ | 2 : 3 | 75% |
| $\frac{4}{6}$ | $\frac{8}{10}$ | 50% | 4 : 6 | 40% | 54% |
| 75 : 100 | 0.54 | 23% | $\frac{4}{5}$ | 0.16 | $\frac{2}{3}$ |
| 0.1 | 33% | 2 : 5 | $\frac{1}{10}$ | $\frac{3}{4}$ | 0.80 |

THIS PAGE IS LEFT BLANK

UNIT 6 NUMBER RELATIONSHIPS

BLM 1 Place Value Charts II

| Billions | Millions | | | Thousands | | | Ones | | |
|----------|----------|-----|-----|-----------|-----|-----|---------|-----|-----|
| One | Hundred | Ten | One | Hundred | Ten | One | Hundred | Ten | One |
| | | | | | | | | | |
| | | | | | | | | | |
| | | | | | | | | | |
| | | | | | | | | | |

| Billions | Millions | | | Thousands | | | Ones | | |
|----------|----------|-----|-----|-----------|-----|-----|---------|-----|-----|
| One | Hundred | Ten | One | Hundred | Ten | One | Hundred | Ten | One |
| | | | | | | | | | |
| | | | | | | | | | |
| | | | | | | | | | |
| | | | | | | | | | |

| Billions | Millions | | | Thousands | | | Ones | | |
|----------|----------|-----|-----|-----------|-----|-----|---------|-----|-----|
| One | Hundred | Ten | One | Hundred | Ten | One | Hundred | Ten | One |
| | | | | | | | | | |
| | | | | | | | | | |
| | | | | | | | | | |
| | | | | | | | | | |

| Billions | Millions | | | Thousands | | | Ones | | |
|----------|----------|-----|-----|-----------|-----|-----|---------|-----|-----|
| One | Hundred | Ten | One | Hundred | Ten | One | Hundred | Ten | One |
| | | | | | | | | | |
| | | | | | | | | | |
| | | | | | | | | | |
| | | | | | | | | | |

| Billions | Millions | | | Thousands | | | Ones | | |
|----------|----------|-----|-----|-----------|-----|-----|---------|-----|-----|
| One | Hundred | Ten | One | Hundred | Ten | One | Hundred | Ten | One |
| | | | | | | | | | |
| | | | | | | | | | |
| | | | | | | | | | |
| | | | | | | | | | |

THIS PAGE IS LEFT BLANK

BLM 2 Place Value Charts III

| Tens | Ones | Tenths | Hundredths | Thousandths | Ten thousandths |
|------|------|--------|------------|-------------|-----------------|
| | | | | | |
| | | | | | |
| | | | | | |

| Tens | Ones | Tenths | Hundredths | Thousandths | Ten thousandths |
|------|------|--------|------------|-------------|-----------------|
| | | | | | |
| | | | | | |
| | | | | | |

| Tens | Ones | Tenths | Hundredths | Thousandths | Ten thousandths |
|------|------|--------|------------|-------------|-----------------|
| | | | | | |
| | | | | | |
| | | | | | |

| Tens | Ones | Tenths | Hundredths | Thousandths | Ten thousandths |
|------|------|--------|------------|-------------|-----------------|
| | | | | | |
| | | | | | |
| | | | | | |

| Tens | Ones | Tenths | Hundredths | Thousandths | Ten thousandths |
|------|------|--------|------------|-------------|-----------------|
| | | | | | |
| | | | | | |
| | | | | | |

| Tens | Ones | Tenths | Hundredths | Thousandths | Ten thousandths |
|------|------|--------|------------|-------------|-----------------|
| | | | | | |
| | | | | | |
| | | | | | |

THIS PAGE IS LEFT BLANK

BLM 3 100 Charts

| | | | | | | | | | |
|----|----|----|----|----|----|----|----|----|-----|
| 1 | 2 | 3 | 4 | 5 | 6 | 7 | 8 | 9 | 10 |
| 11 | 12 | 13 | 14 | 15 | 16 | 17 | 18 | 19 | 20 |
| 21 | 22 | 23 | 24 | 25 | 26 | 27 | 28 | 29 | 30 |
| 31 | 32 | 33 | 34 | 35 | 36 | 37 | 38 | 39 | 40 |
| 41 | 42 | 43 | 44 | 45 | 46 | 47 | 48 | 49 | 50 |
| 51 | 52 | 53 | 54 | 55 | 56 | 57 | 58 | 59 | 60 |
| 61 | 62 | 63 | 64 | 65 | 66 | 67 | 68 | 69 | 70 |
| 71 | 72 | 73 | 74 | 75 | 76 | 77 | 78 | 79 | 80 |
| 81 | 82 | 83 | 84 | 85 | 86 | 87 | 88 | 89 | 90 |
| 91 | 92 | 93 | 94 | 95 | 96 | 97 | 98 | 99 | 100 |

| | | | | | | | | | |
|----|----|----|----|----|----|----|----|----|-----|
| 1 | 2 | 3 | 4 | 5 | 6 | 7 | 8 | 9 | 10 |
| 11 | 12 | 13 | 14 | 15 | 16 | 17 | 18 | 19 | 20 |
| 21 | 22 | 23 | 24 | 25 | 26 | 27 | 28 | 29 | 30 |
| 31 | 32 | 33 | 34 | 35 | 36 | 37 | 38 | 39 | 40 |
| 41 | 42 | 43 | 44 | 45 | 46 | 47 | 48 | 49 | 50 |
| 51 | 52 | 53 | 54 | 55 | 56 | 57 | 58 | 59 | 60 |
| 61 | 62 | 63 | 64 | 65 | 66 | 67 | 68 | 69 | 70 |
| 71 | 72 | 73 | 74 | 75 | 76 | 77 | 78 | 79 | 80 |
| 81 | 82 | 83 | 84 | 85 | 86 | 87 | 88 | 89 | 90 |
| 91 | 92 | 93 | 94 | 95 | 96 | 97 | 98 | 99 | 100 |

| | | | | | | | | | |
|----|----|----|----|----|----|----|----|----|-----|
| 1 | 2 | 3 | 4 | 5 | 6 | 7 | 8 | 9 | 10 |
| 11 | 12 | 13 | 14 | 15 | 16 | 17 | 18 | 19 | 20 |
| 21 | 22 | 23 | 24 | 25 | 26 | 27 | 28 | 29 | 30 |
| 31 | 32 | 33 | 34 | 35 | 36 | 37 | 38 | 39 | 40 |
| 41 | 42 | 43 | 44 | 45 | 46 | 47 | 48 | 49 | 50 |
| 51 | 52 | 53 | 54 | 55 | 56 | 57 | 58 | 59 | 60 |
| 61 | 62 | 63 | 64 | 65 | 66 | 67 | 68 | 69 | 70 |
| 71 | 72 | 73 | 74 | 75 | 76 | 77 | 78 | 79 | 80 |
| 81 | 82 | 83 | 84 | 85 | 86 | 87 | 88 | 89 | 90 |
| 91 | 92 | 93 | 94 | 95 | 96 | 97 | 98 | 99 | 100 |

| | | | | | | | | | |
|----|----|----|----|----|----|----|----|----|-----|
| 1 | 2 | 3 | 4 | 5 | 6 | 7 | 8 | 9 | 10 |
| 11 | 12 | 13 | 14 | 15 | 16 | 17 | 18 | 19 | 20 |
| 21 | 22 | 23 | 24 | 25 | 26 | 27 | 28 | 29 | 30 |
| 31 | 32 | 33 | 34 | 35 | 36 | 37 | 38 | 39 | 40 |
| 41 | 42 | 43 | 44 | 45 | 46 | 47 | 48 | 49 | 50 |
| 51 | 52 | 53 | 54 | 55 | 56 | 57 | 58 | 59 | 60 |
| 61 | 62 | 63 | 64 | 65 | 66 | 67 | 68 | 69 | 70 |
| 71 | 72 | 73 | 74 | 75 | 76 | 77 | 78 | 79 | 80 |
| 81 | 82 | 83 | 84 | 85 | 86 | 87 | 88 | 89 | 90 |
| 91 | 92 | 93 | 94 | 95 | 96 | 97 | 98 | 99 | 100 |

| | | | | | | | | | |
|----|----|----|----|----|----|----|----|----|-----|
| 1 | 2 | 3 | 4 | 5 | 6 | 7 | 8 | 9 | 10 |
| 11 | 12 | 13 | 14 | 15 | 16 | 17 | 18 | 19 | 20 |
| 21 | 22 | 23 | 24 | 25 | 26 | 27 | 28 | 29 | 30 |
| 31 | 32 | 33 | 34 | 35 | 36 | 37 | 38 | 39 | 40 |
| 41 | 42 | 43 | 44 | 45 | 46 | 47 | 48 | 49 | 50 |
| 51 | 52 | 53 | 54 | 55 | 56 | 57 | 58 | 59 | 60 |
| 61 | 62 | 63 | 64 | 65 | 66 | 67 | 68 | 69 | 70 |
| 71 | 72 | 73 | 74 | 75 | 76 | 77 | 78 | 79 | 80 |
| 81 | 82 | 83 | 84 | 85 | 86 | 87 | 88 | 89 | 90 |
| 91 | 92 | 93 | 94 | 95 | 96 | 97 | 98 | 99 | 100 |

| | | | | | | | | | |
|----|----|----|----|----|----|----|----|----|-----|
| 1 | 2 | 3 | 4 | 5 | 6 | 7 | 8 | 9 | 10 |
| 11 | 12 | 13 | 14 | 15 | 16 | 17 | 18 | 19 | 20 |
| 21 | 22 | 23 | 24 | 25 | 26 | 27 | 28 | 29 | 30 |
| 31 | 32 | 33 | 34 | 35 | 36 | 37 | 38 | 39 | 40 |
| 41 | 42 | 43 | 44 | 45 | 46 | 47 | 48 | 49 | 50 |
| 51 | 52 | 53 | 54 | 55 | 56 | 57 | 58 | 59 | 60 |
| 61 | 62 | 63 | 64 | 65 | 66 | 67 | 68 | 69 | 70 |
| 71 | 72 | 73 | 74 | 75 | 76 | 77 | 78 | 79 | 80 |
| 81 | 82 | 83 | 84 | 85 | 86 | 87 | 88 | 89 | 90 |
| 91 | 92 | 93 | 94 | 95 | 96 | 97 | 98 | 99 | 100 |

THIS PAGE IS LEFT BLANK

UNIT 7 DATA AND PROBABILITY

BLM 1 Fraction Circles for Spinners

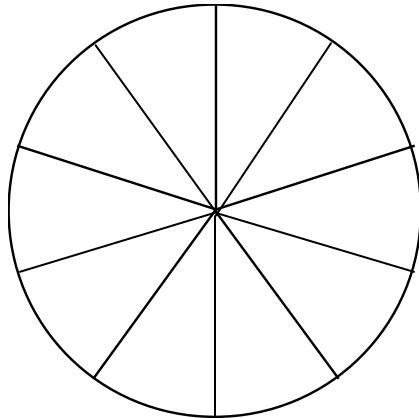
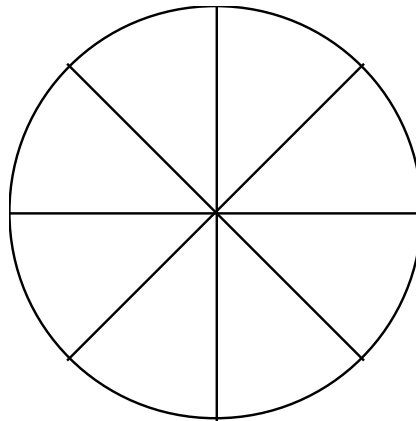
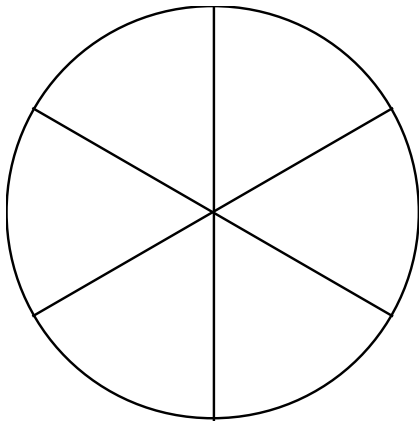
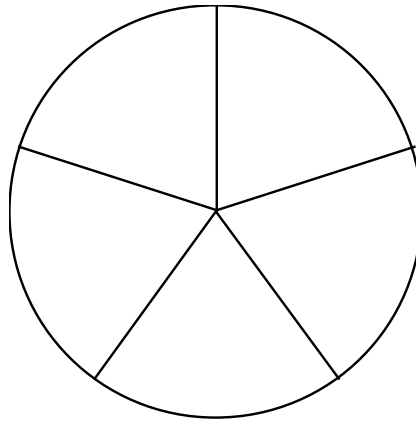
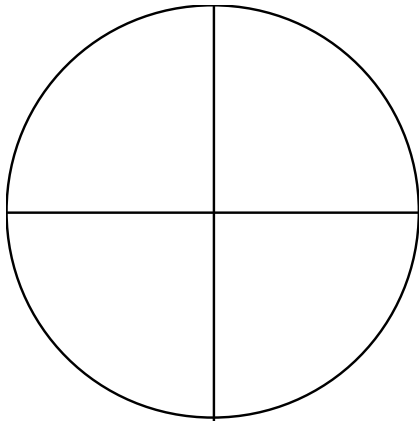
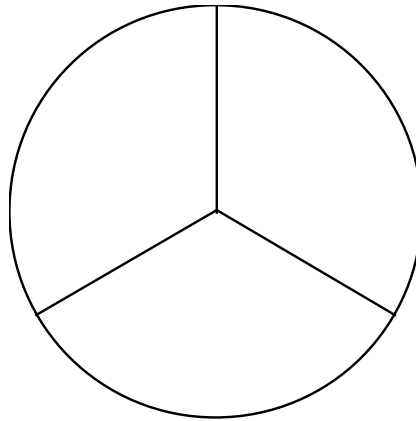
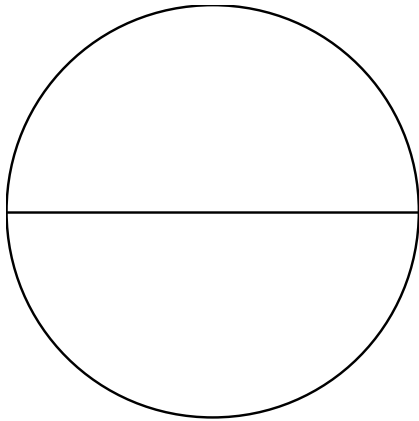

THIS PAGE IS LEFT BLANK